

THE DEFINITIVE GUIDE TO
**SYNCHRONIZED
CLOCK SYSTEMS**



TABLE OF CONTENTS

03	Part One:	Introduction to Synchronized Clock Systems
04		Section 1: What are Synchronized Clock Systems and why are they needed?
28		Section 2: What types of Synchronized Clock Systems are available?
38		Section 3: How are Synchronized Clocks Systems configured?
40	Part Two:	The Synchronized Clock System Planning Process
41		Section 1: Choosing the right Synchronized Clock System for your facility?
52		Section 2: Which Synchronized Clock Systems are energy efficient?
54		Section 3: How to build a Synchronized Clock System
70	Conclusion:	Putting Your Knowledge to Good Use
71	Glossary of Terms	

PART 1:
INTRODUCTION TO
SYNCHRONIZED CLOCK SYSTEMS



SECTION 1:

WHAT ARE SYNCHRONIZED CLOCK SYSTEMS AND WHY ARE THEY NEEDED?



SECTION 1: What are Synchronized clocks and why are they needed?

SYNCHRONIZED CLOCK SYSTEMS DEFINED

Synchronized clock systems ensure that every clock in a facility displays the same, precise time that is traceable to official time.

With increasing demand for official traceable time, efficient operations and streamlined workforces, synchronized clock systems have become a vital fixture to help maximize employee time, increase productivity, achieve regulatory compliance, and ultimately reduce maintenance and labor costs.

By using a synchronized clock system, a facility is able to maintain accurate time across work stations, offices, departments and buildings to streamline processes, effectively manage workflow and harmonize occupants. Synchronized clocks are beneficial in many environments-such as education, manufacturing, distribution, corporate, financial, transportation, sports teams and municipal organizations. In some cases synchronized time is mandated to meet time recording regulations.

Synchronized clock configurations and applications discussed in this guide include:

- Radio Frequency Wireless Clocks
- Power over Ethernet IP Network Clocks
- Wi-Fi Wireless Clocks
- Product Applications
- Official NTP Time Sources
- Daylight Saving Time
- Analog Synchronized Clocks
- Digital Synchronized Clocks
- Energy Efficiency



SECTION 1: What are Synchronized Clocks and why are they needed?

WHY SYNCHRONIZED CLOCKS ARE NEEDED

When every clock in a facility displays the same, precise time, its occupants are in harmony with each other-employees are accountable and punctual, schedules are met and time recording documentation is 100% accurate.

If every clock displays a different time, there is room for error and down time. Tardiness, idleness, missed deadlines and inaccurate time documentation can cost your company thousands of dollars each year. You don't want employees showing up late for a client meeting, or shipping personnel missing a scheduled pick-up. Synchronized clocks help your company achieve optimum productivity and efficiency.

Synchronized clocks can help staff spend more time working and less time wasting time by providing a highly visible accurate time source anywhere in a facility. Take a look around you. The wall clock in your office, your PC, and your cell phone are probably displaying different times. Even discrepancies of a few seconds can lead to organization-wide inaccuracies. And time wasted means lost productivity.

Many industries also mandate regulatory compliance and accurate timekeeping, such as the healthcare and food processing sectors. Synchronized clocks help organizations comply with federal, state and industry-specific time mandates.

Synchronized clocks increase facility productivity and efficiency, and ultimately help the bottom line.



Improves employee punctuality & accountability



SECTION 1: What are Synchronized Clocks and why are they needed?

SYNCHRONIZED CLOCKS HELP THE BOTTOM LINE

A Synchronized Clock System can pay for itself in a matter of months.

Imagine saving your company over \$40K just by installing a Synchronized Clock System? It's not a far fetched concept. Synchronized clocks eliminate time confusion and tardiness, keeping employees accountable and productivity on track.

If the clock in the break room is 5 minutes slow and one employee takes an extra 5 minutes before heading back to work, you might think it's no big deal. But if 100 employees waste 5 minutes per day, it can cost a company thousands of dollars per year in labor and lost productivity.

If your company can save labor costs and improve facility productivity and efficiency, they help the bottom line.

LABOR SAVINGS	
Number of Hourly Employees	100
Minutes Saved per Day per Hourly Employee	5
Total Minutes Saved per Day	500
Total Minutes Saved per Month*	11,000
Hours Saved per Month	183
Average Hour Rate	\$20/hour
Average Monthly Savings	\$3,660.00
Savings Over One Year	x12
Annual Savings	\$42,920.00

* Based on average of 22 works days per month



Helps the bottom line

SECTION 1: What are Synchronized Clocks and why are they needed?

WHY SYNCHRONIZED CLOCKS ARE NEEDED IN HEALTHCARE



SECTION 1: What are Synchronized Clocks and why are they needed?

WHY SYNCHRONIZED CLOCKS ARE NEEDED IN HEALTHCARE

Synchronized Clock Systems improve risk management and meet AHA, HIPAA, Joint Commission & Medicare timekeeping regulations in the healthcare environment.

Accurate time is critical in healthcare facilities where life-saving decisions are made every second of every day. Efficient patient throughput, standardized schedules, timely medication disbursement, accurate medical record maintenance and compliance with timekeeping regulations imposed by the American Hospital Association, HIPAA, Joint Commission & Medicaid/Medicare all rely on precisely synchronized time from the emergency room to the patient's room.

Synchronized clocks meet timekeeping mandates by ensuring reliable synchronized timekeeping throughout an entire healthcare facility.

REGULATIONS: HIPAA

Security and Electronic Signature Standards (2002) addresses the following policies, practices, and procedures:

Security and Confidentiality Policies

- Requirement for a time source behind the firewall for secure and accurate networking.

Audit Trails

- Requirement for Legally Traceable Time to support Time Stamps, Audit Trails, File Logs, etc...that HIPAA mandates, especially as it relates to Electronic Health Records.

JOINT COMMISSION ELEMENTS OF PERFORMANCE RELATING TO TIMEKEEPING

- PC.03.05.05, EP 1
- RC.01.01.01, EP 19
- RC.02.03.07, EP 4
- RC.02.03.07, EP 6



Provides time accuracy in patient records & medication disbursement



Assists in Medicare Reimbursement requirements (DRG Incentive)



Helps meet HIPAA time synchronization mandates



Complies with Joint Commission timekeeping regulations

SECTION 1: What are Synchronized Clocks and why are they needed?

WHAT CLOCK FORMATS ARE NEEDED IN HEALTHCARE

Highly visible LED digital 6-digit (00:00:00) provide detailed time keeping and Code Blue digital timers are essential for critical time events.

When selecting the appropriate clock formats for the healthcare facility, consider the needs of each department, such as the OR, ICU or patient room.

6-Digit Digital LED Clock

6-digit 00:00:00 digital clock format meets detailed time and record keeping requirements for medical records, audit trails and medication disbursement.

Analog Clock

Standard 12-hour face analog synchronized clocks maintain accurate time in patient rooms and general areas and meet record keeping requirements for medical records, audit trails and medication disbursements.

Code Blue Digital Timer

A Code Blue Digital Timer precisely monitors elapsed and remaining time during emergency response, lab testing, and other time-sensitive events. The system can also be used in Emergency Rooms, Operating Rooms and Simulation Labs to effectively assess elapsed time during patient procedures. When not in timer mode, the digital clock can be used in conjunction with a Synchronized Clock System to provide accurate time display.



Digital Timer System measures elapsed time during Code Blue Emergencies



SECTION 1: What are Synchronized Clocks and why are they needed?

WHY SYNCHRONIZED CLOCKS ARE NEEDED IN FOOD PROCESSING



SECTION 1: What are Synchronized Clocks and why are they needed?

WHY SYNCHRONIZED CLOCKS ARE NEEDED IN FOOD PROCESSING

Synchronized Clock Systems meet FDA and USDA regulations requiring synchronization of clocks and accurate time measures.

Accurate time is essential in food processing facilities where precision in time-critical activities is paramount to product quality and safe food handling. Filling, seaming, heating, cooling, sterilization timing and compliance with FDA/USDA code and regulations rely on precisely synchronized time at every processing station.

Synchronized clocks meet synchronization standards and time measure requirements by automatically maintaining accurate synchronized time across processing stations, departments and throughout an entire food processing facility.

REGULATIONS: 9 CFR 318.304

(d) **Timing devices.** Devices used to time applicable thermal processing operation functions or events, shall be accurate to assure that all functions or events are achieved. Pocket watches and wrist watches are not considered acceptable time devices. Analog and digital clocks are considered acceptable. Time recording devices shall correspond within 15 minutes of the time of the day recorded or written records required by 318.306

21 CFR 113.100

(1) **Still retorts.** Time steam on, time temperature up to processing temperature; time steam off; venting time and temperature to which vented.

(i) **Timing method(s).** Method(s) shall be used either to give the retention time of containers, and closures if applicable, in the sterilizing environment, specified in the scheduled process, or to control the sterilization cycle at the rate specified in the schedule process. The time and temperature of processing and other critical factors specified in the scheduled process shall be measured with instruments having the accuracy and dependability adequate to ensure that the requirements of the scheduled process are met.

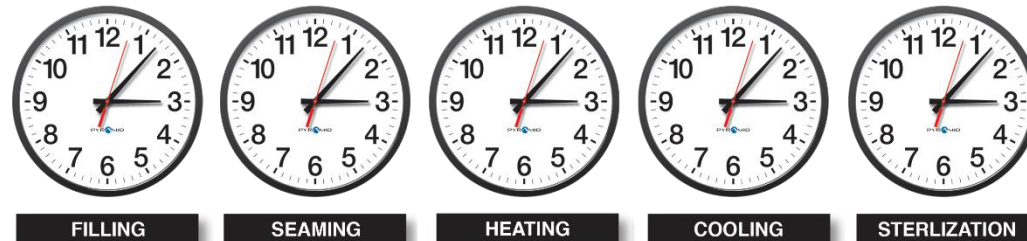

SECTION 1: What are Synchronized Clocks and why are they needed?

WHAT CLOCK FORMATS ARE NEEDED IN FOOD PROCESSING

LED digital 4 inch character, 6-digit (00:00:00) clocks provide highly visible time keeping in expansive processing station areas. Count Up/Count Down digital timers are essential during time-critical tasks.

When selecting the appropriate clock formats for the food processing facility, consider the needs of each food processing station as well as in expansive areas.

4" Character, 6-Digit Digital LED Clock

4" character, 6-digit 00:00:00 display provides highly visible, accurate time reference for shift changes, production activities, timed processes and shipping schedules. Complies with FDA Code and Regulations requiring synchronization of clocks.

Count Up/Count Down Digital Timer

A Count Up/Count Down Digital Timer provides a visual indication of elapsed or remaining time during time-critical tasks such as filling, seaming, heating, cooling and sterilization. Meets USDA requirement for accurate time measures.

Analog Clock

Standard 12-hour face analog synchronized clocks maintain accurate time throughout departments.



Digital Timer System provides precision in time-critical tasks such as filling, seaming, heating & cooling



Complies with FDA Code & Regulations requiring synchronization of clocks



Meets USDA requirements for accurate time measures



Vibrant red LED digital clocks provide optimum visibility



SECTION 1: What are Synchronized Clocks and why are they needed?

WHY SYNCHRONIZED CLOCKS ARE NEEDED IN EDUCATION



SECTION 1: What are Synchronized Clocks and why are they needed?

WHY SYNCHRONIZED CLOCKS ARE NEEDED IN EDUCATION

Synchronized Clock Systems improve punctuality and standardize schedules in the educational environment.

School districts and college campuses require a highly visible, accurate time source. Synchronized time is essential to managing arrival times, lunches, departure times, class changes, extracurricular activities, student assemblies, faculty meetings, standardized testing and bus waves.

Synchronized clocks automatically maintain accurate synchronized time between the district office, main office, general areas, classrooms, district or campus-wide.

Synchronized clocks improve student and faculty accountability and punctuality, in addition to standardizing class changes, bus waves and extracurricular activity schedules.



Synchronizes Time



Standardizes Class Changes



SECTION 1: What are Synchronized Clocks and why are they needed?

WHAT CLOCK FORMATS ARE NEEDED IN EDUCATION

12-Hour with seconds analog clock face provides detailed time keeping in the educational environment.

When selecting the appropriate clock formats for the educational facility, consider the needs of the classrooms, general purpose areas and administrative offices.

13" or 17" Analog Clock with Seconds

A standard 12-Hour face analog clock with seconds provides detailed time and attendance record keeping requirements.

Clearly marked five minute increments assist elementary grade students in learning how to tell time (as shown in photo below).

Count Up/Count Down Digital Timer

A Count Up/Count Down Digital Timer with 00:00:00 time display provides a visual indication of elapsed or remaining time during standardized testing, sporting events, lab exercises and emergency preparedness drills.



Wood Bezel Analog Clock

Hardwood bezel clocks provide an aesthetically pleasing synchronized time reference in administrative offices, main reception areas and meeting rooms.



Bell Systems

Synchronized Clock Systems easily integrate with bell and tone systems.



Variety of Clock Face Formats



Digital Timers for timed testing & events



Bell System Integration



SECTION 1: What are Synchronized Clocks and why are they needed?
WHY SYNCHRONIZED CLOCKS ARE NEEDED IN
MANUFACTURING/DISTRIBUTION

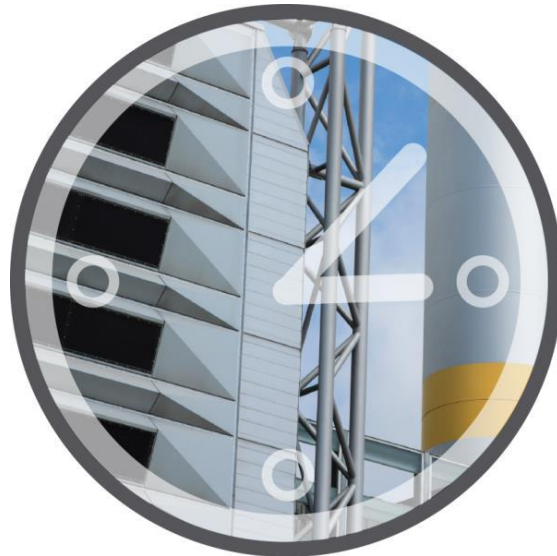

SECTION 1: What are Synchronized Clocks and why are they needed?

WHY SYNCHRONIZED CLOCKS ARE NEEDED IN MANUFACTURING/DISTRIBUTION

Synchronized Clock Systems improve productivity, promote efficiency and eliminate facility maintenance costs in manufacturing and distribution centers.

Manufacturing processes, shift changes and shipping schedules are dependent upon accurate timing. Synchronized time is essential to managing daily operations, harmonizing the workplace, and streamlining processes.

Synchronized clocks prominently display the same exact time across the production floor, warehouse, shipping department, front office, customer service and throughout an entire manufacturing or distribution facility.

Synchronized clocks upholds *the LEAN manufacturing philosophy* by maximizing the workforce, streamlining processes and improving productivity.

Employee accountability, punctuality and standardized shift changes are achieved through time synchronization. Synchronized clocks essentially eliminate excuses for being late.



Synchronizes Time



Standardizes Shift Changes



Maximizes workforce, streamlines processes and improves productivity



SECTION 1: What are Synchronized Clocks and why are they needed?

WHAT CLOCK FORMATS ARE NEEDED IN MANUFACTURING/DISTRIBUTION

LED digital 4 inch character, 4-digit (00:00) provide highly visible timekeeping on expansive production floors. Count Up/Count Down digital timers are essential during timed processes.

When selecting the appropriate clock formats for the manufacturing or distribution environment, consider the needs of the expansive production floor, shipping warehouses and front office areas.

4" Character, 4-Digit Digital LED Clock
4" character, 4-digit 00:00 display provides highly visible, accurate time reference for shift changes, production activities, timed processes and shipping schedules.

Count Up/Count Down Digital Timer
A Count Up/Count Down Digital Timer provides a visual indication of elapsed or remaining time during timed production events. Timers can also be used to monitor performance or ongoing quality improvement activities.

Analog Clock
Provides synchronized time reference in administrative offices, main reception areas and meeting rooms.



Vibrant red LED digital clocks provide optimum visibility



Digital Timer provides time measures for critical production events



SECTION 1: What are Synchronized Clocks and why are they needed?
WHY SYNCHRONIZED CLOCKS ARE NEEDED IN
GOVERNMENT



SECTION 1: What are Synchronized Clocks and why are they needed?

WHY SYNCHRONIZED CLOCKS ARE NEEDED IN GOVERNMENT

Synchronized Clock Systems improve productivity, promote efficiency and provide an official time source in government organizations.

Workflow, interdepartmental activity, meetings, deadlines and employee schedules are dependent upon accurate timing. Synchronized time is essential to managing day to day operations at local, state and federal government organizations.

Synchronized clocks prominently display the same exact time across work stations, offices, departments, meeting rooms, break areas and throughout an entire municipal facility.

FEMA's Comprehensive Preparedness Guide (CPG) 101 challenges local government to establish effective *Emergency Operation Plans (EOP's)* which provide rapid and rigorous coordination, integration and synchronization of incident response.

Most Synchronized Clock Systems reference an official time source, such as Network Time Protocol (NTP) obtained from US government satellites. Using an official time source helps agencies comply with federal and state time standards.



Synchronizes Time



Reference an official NTP time source



LOBBY



MAIN OFFICE



RECORDS OFFICE



CONFERENCE ROOM



BREAK ROOM

SECTION 1: What are Synchronized Clocks and why are they needed?

WHAT CLOCK FORMATS ARE NEEDED IN GOVERNMENT

LED digital 4 inch character, 4-digit (00:00) clocks provide highly visible am/pm or military time. Count Up/Count Down digital timers help establish Emergency Operation Plans.

When selecting the appropriate clock formats for a government agency, consider the needs of the physical environment, such as expansive public spaces, long hallways or office areas. Also contemplate operational requirements, such as Emergency Response or Military sectors.

4" Character, 4-Digit Digital LED Clock
4" character, 4-digit 00:00 display provides highly visible, accurate time reference in am/pm or military time format.

Count Up/Count Down Digital Timer

A Count Up/Count Down Digital Timer can be used to evaluate and improve effectiveness of *Emergency Operation Plans* by measuring time intervals to complete common functions during training and simulated event session.

Analog Clock

Provides synchronized time reference in administrative offices, main reception areas and meeting rooms.



Vibrant red LED digital clocks provide optimum visibility



Digital Timer provides time measures for Emergency Operation Plans



SECTION 1: What are Synchronized Clocks and why are they needed?

WHY SYNCHRONIZED CLOCKS ARE NEEDED IN SPORTS TEAM TRAINING CENTERS



SECTION 1: What are Synchronized Clocks and why are they needed?

WHY SYNCHRONIZED CLOCKS ARE NEEDED IN SPORTS TEAM TRAINING CENTERS

Synchronized Clock Systems improve staff and athlete punctuality, improve productivity, and tighten up training schedules in team training facilities.

Training schedules, practice sessions and team meetings are dependent upon accurate timing. Synchronized time is essential to help maximize practice time, increase athlete productivity and optimize sports facility operations.

Synchronized clocks prominently display the same exact time across training rooms, locker rooms, meeting rooms and throughout an entire sports training facility.

Staff and athletes are accountable and punctual, schedules are standardized, productivity is improved and operations run more efficiently.



Synchronizes time



Standardizes practice schedules



ADMIN OFFICE



LOCKER ROOM



WEIGHT ROOM



INDOOR FIELD



CONFERENCE ROOM

SECTION 1: What are Synchronized Clocks and why are they needed?

WHAT CLOCK FORMATS ARE NEEDED IN SPORTS TEAM TRAINING CENTERS

LED digital 4 inch character, 6-digit (00:00:00) clocks provide highly visible time in expansive areas. Count Up/Count Down digital timers provide elapsed or remaining time during training activities.

When selecting the appropriate clock formats for a sports team complex, consider the needs of the physical environment, such as expansive indoor fields, training rooms or meeting rooms.

4" Character, 6-Digit Digital LED Clock
Ultra-bright red LED digital clocks are highly visible in large expansive areas. 4" character, 6-digit 00:00:00 display provides precise time reference.

Count Up/Count Down Digital Timer
A Count Up/Count Down Digital Timer with 00:00:00 time display provides a visual indication of elapsed or remaining time during training activities.

13" or 17" Analog Clock
Provides synchronized time reference in administrative offices, main reception areas and meeting rooms. Custom team logo clock faces are also available.



Vibrant red LED digital clocks provide optimum visibility



Digital Timer provides precision in time-critical training



SECTION 1: What are Synchronized Clocks and why are they needed?

WHY SYNCHRONIZED CLOCKS ARE NEEDED

Synchronized clocks automatically adjust for Daylight Saving Time or power outages and eliminate the task of climbing a ladder to manually reset every clock.

What about Spring Ahead and Fall Behind or power outages? Synchronized clocks automatically adjust for Daylight Saving Time and power outages without missing a tick.

The Daylight Saving Time schedule is transmitted to each clock to automatically adjust the time at the start and end of DST each year. Synchronized clocks are also unscathed by power outages since the analog clocks can run on batteries, and digital clocks maintain an internal real time clock (RTC) to continue keeping time until power is restored.

The facilities management staff will no longer spend valuable time manually resetting clocks, freeing them up for more pressing matters and mitigating safety risks associated with climbing ladders to reach the clocks.

MAINTENANCE LABOR SAVINGS	
Cost of Adjusting Clocks for Daylight Saving Time	
Number of Clocks	100
Minutes Spent to Change Batteries & Reset Time Per Clock	15
Total Minutes Spent per Daylight Saving Time Adjustment	1500
Number of Daylight Saving Time Adjustments per Year	X2
Total Minutes Saved per Year	3000
Total Hours Saved	50
Average Maintenance Hourly Wage	\$20/hour
Total Annual Savings	\$1,000.00



Automatic DST Adjustment

SECTION 1: What are Synchronized Clocks and why are they needed?

WHY SYNCHRONIZED CLOCKS ARE NEEDED - REVIEW



Improves punctuality & accountability



Helps the bottom line



Synchronizes time throughout an entire facility



Standardized schedules



Variety of clock face formats



Digital Timers for timed events



Automatically adjusts for Daylight Saving Time & power outages

SECTION 2:

WHAT TYPES OF SYNCHRONIZED CLOCK SYSTEMS ARE AVAILABLE?

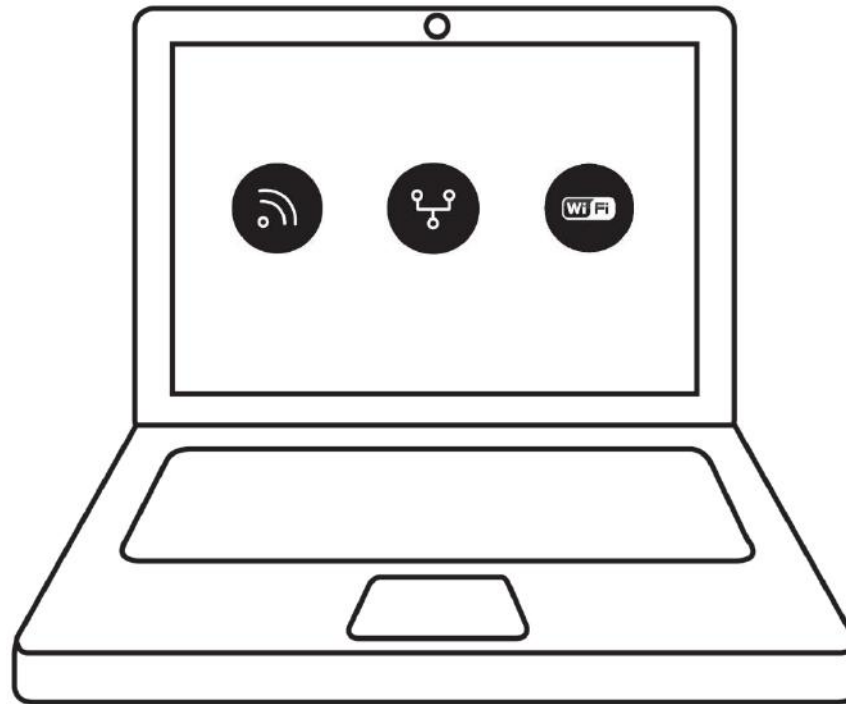

SECTION 2: What types of Synchronized Clock Systems are available and how do they receive official time?

THE EVOLUTION OF SYNCHRONIZED CLOCKS

Synchronized Clock Systems are light years ahead of the “old-school” hard-wired master clock systems of yesteryear. The emergence of wireless technology provides efficient new methods of clock synchronization.

In the age of wireless technology, organizations are able to harness the available facility infrastructure by choosing the appropriate clock application(s) for a specific environment. All of the platforms discussed in this section use clock synchronization software to configure time settings and manage wall clocks or compatible devices, such as bell or tone systems.



Radio Frequency Wireless Synchronized Clock System

Uses dependable frequency-hopping technology to continuously broadcast a time signal over 128 signaling channels (902MHz-928MHz) through a network based transmitter



Power over Ethernet IP Network Synchronized Clock System

Provides consistent accurate time data and power to wall clocks through a standard CAT5 Ethernet cable (IEEE.802.3af)



Wi-Fi Wireless Clock System

Communicates accurate time to wall clocks using Wi-Fi access points (802.11b,g)

THEN

Costly electrical wiring

Universal device time source/zone selection

Limited number of clocks per system

NOW

Cost effective Ethernet, Wireless Radio Frequency or Wireless Wi-Fi

Universal or individual time source/zone selection (PoE System)

Unlimited number of clocks per system

SECTION 2: What types of Synchronized Clock Systems are available and how do they receive official time?

OFFICIAL TIME SOURCES

Using an official time source provides legally validated time stamps and operational efficiency.

Regardless of the type of Synchronized Clock System, all of them reference an official time source. Accurate time is crucial to a variety of industries and activities which rely on precise timing for synchronization and operational efficiency. UTC (NIST) and the Global Positioning System (GPS) provide accurate, legally traceable time data.

Time Synchronization software allows the user to choose between NTP or GPS time synchronization.

Network Time Protocol (NTP) is a networking protocol for clock synchronization between computer systems over data networks. NTP can maintain time within tens of milliseconds of *Coordinated Universal Time (UTC)* NIST over the internet, and can achieve better than one millisecond accuracy in local area networks under ideal conditions. UTC (NIST) is the Coordinated Universal Time scale maintained by The National Institute of Standards and Technology.

In addition to longitude, latitude, and altitude, the *Global Positioning System (GPS)* provides official time. Each GPS satellite contains multiple atomic clocks that feed precise time data to the GPS signals. Using a GPS receiver to capture GPS time signals, official time is transmitted to clocks and other devices.

Companies worldwide use NTP and GPS to synchronize their network computers and clocks.



SECTION 2: What are RF Wireless Synchronized Clocks and how do they receive time? RF WIRELESS SYNCHRONIZED CLOCKS DEFINED

Radio Frequency (RF) Wireless Synchronized Clocks receive a wireless time signal from an Ethernet-based transmitter.

Locally broadcast wireless radio signals entered the clock synchronization circle in the early 2000s. This type of system includes a centralized transmitter that receives an official time signal and broadcasts the signal to clocks, bell ringers and other devices throughout a facility.

A **Wireless RF transmitter** captures time from an assigned NTP (Network Time Protocol) time source or GPS Receiver and communicates accurate time data to an unlimited number of analog or digital wall clocks wirelessly using radio frequency. Depending on the wattage, an RF Wireless transmitter requires an FCC license to operate, however some models, such as an RF Wireless 1 watt Transmitter, do not require a license.

Radio Frequency Wireless clocks may be battery operated (analog & LCD digital) or electric (analog & LED digital).

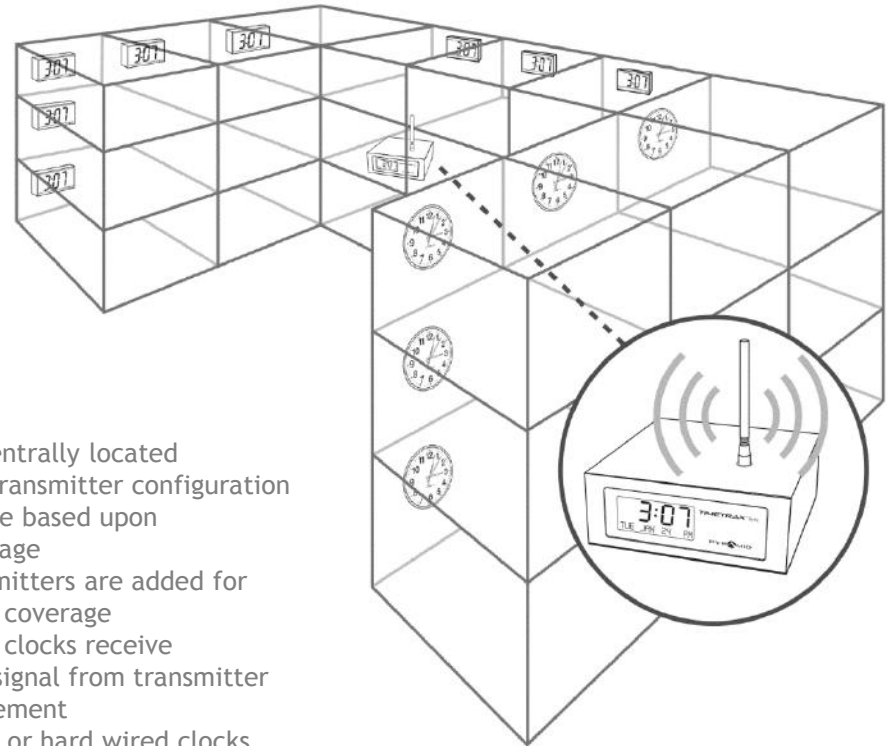

Wireless RF Clocks

- Transmitter is centrally located
- 1, 5 or 20 Watt transmitter configuration
- Wireless coverage based upon transmitter wattage
- Secondary transmitters are added for additional signal coverage
- Analog or digital clocks receive consistent time signal from transmitter
- Software management
- Battery powered or hard wired clocks
- Uses the least amount of IT resources

SECTION 2: What are RF Wireless Synchronized Clocks and how do they receive time? RF WIRELESS SYNCHRONIZED CLOCKS DEFINED

There are three distinct radio frequencies available to transmit a synchronization signal to clocks.

Synchronized clock systems may use one of three available radio frequencies to transmit a time signal. Each frequency requires a specific set of conditions and output power to ensure successful signal transmission.

System Frequency Options

72 MHz

Typically uses a 1watt transmitter for up to 100,000 square feet of signal coverage. Larger facilities may require a transmitter outfitted with an external roof antenna. This configuration typically outputs power levels of 5-30 watts to deliver the signal to clocks. The 72MHz frequency is less congested, has low interference, but does require an FCC license. This frequency is able to penetrate exterior walls and commercial building materials, such as stone, metal, concrete and brick.

460-480MHz

Requires a power output level of 50-100 watts to send a signal across a building or campus. This frequency carries strict FCC regulations since the powerful signal is likely to cause interference with radio-based products within the same range. The 460-480MHz frequency is heavily shared by licensees such as law enforcement and taxis, and has a high probability of interference. The signal is also likely to be unable to penetrate thick walls or dense construction materials.

900MHz

Uses a 1watt transmitter for up to 250,000 square feet of signal coverage and does not require an FCC license. Larger facilities or dense facility contents may require a secondary transmitter to increase signal coverage. This frequency is also used by a wide range of products and has a greater potential for signal interference, unless using Frequency Hopping Spread Spectrum method (discussed on next page).



SECTION 2: What are RF Wireless Synchronized Clocks and how do they receive time? RF WIRELESS SYNCHRONIZED CLOCKS DEFINED

Frequency Hopping Spread Spectrum method.

Frequency Hopping Spread Spectrum allows a network based RF Wireless transmitter to frequency-hop the transmission, ensuring the clocks will receive the correct time despite interference on any of the frequencies.

Frequency Hopping Spread Spectrum (FHSS) is a method of transmitting or spreading radio signals over rapidly changing frequencies. The carrier signal “hops” in a random but predictable sequence from frequency to frequency.

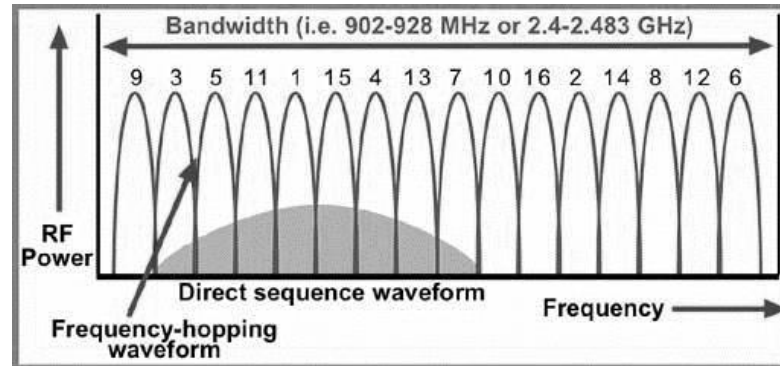

A spread-spectrum transmission offers three main advantages over a fixed-frequency transmission:

- Spread-spectrum signals are highly resistant to narrowband interference. The process of re-collecting a spread signal spreads out the interfering signal, causing it to recede into the background.
- Spread-spectrum signals are difficult to intercept. A spread-spectrum signal may simply appear as an increase in the background noise to a narrowband receiver.
- Spread-spectrum transmissions can share a frequency band with many types of conventional transmissions with minimal interference. The spread-spectrum signals add minimal noise to the narrow-frequency communications, and vice versa. As a result, bandwidth can be used more efficiently.

SECTION 2: What are RF Wireless Synchronized Clocks and how do they receive time? RF WIRELESS SYNCHRONIZED CLOCKS DEFINED

An Ethernet Radio Frequency (RF) Wireless Transmitter sets up in a matter of minutes.

In the example to the right, a Radio Frequency (RF) Wireless Transmitter simply plugs into a standard electrical outlet and Ethernet port to establish a network connection. Once connected, synchronization software discovers the transmitter and allows the user to choose a time source, time zone, and Daylight Saving Time settings.

Additional RF Wireless transmitters may be easily added to increase signal coverage. Shelf mount or wall mount options are available depending on facility needs.

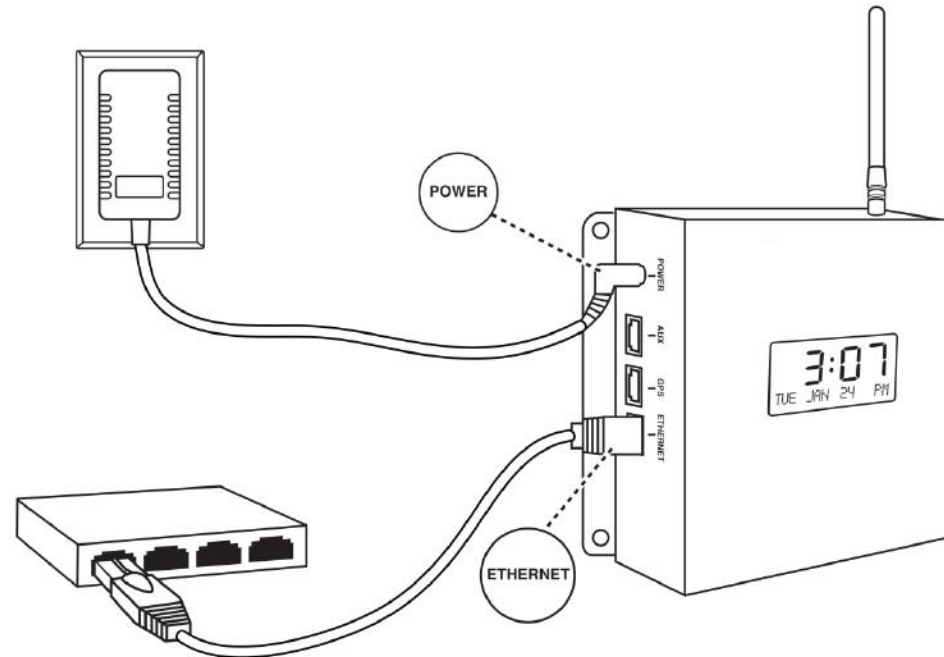

SECTION 2: What are PoE IP Network Synchronized Clocks and how do they receive time?

POE IP NETWORK SYNCHRONIZED CLOCKS DEFINED

Power over Ethernet IP Network Clocks receive power and reliable time over a local area network (LAN) or wide area network (WAN) using one Ethernet cable.

PoE or IP Network Synchronized Clocks leverage the existing Ethernet infrastructure in a facility by receiving continuous reliable time over an existing Local area network (LAN) or Wide area network (WAN) using standard Ethernet cabling. PoE Clocks may also be powered over the Ethernet (IEEE.802.3af), making them a cost-effective solution for any industry.

PoE IP Network clocks are extremely economical and simple to install since they do not require costly electrical wiring or additional outlets. Synchronization software also allows the user to assign independent time settings/zones for each clock.

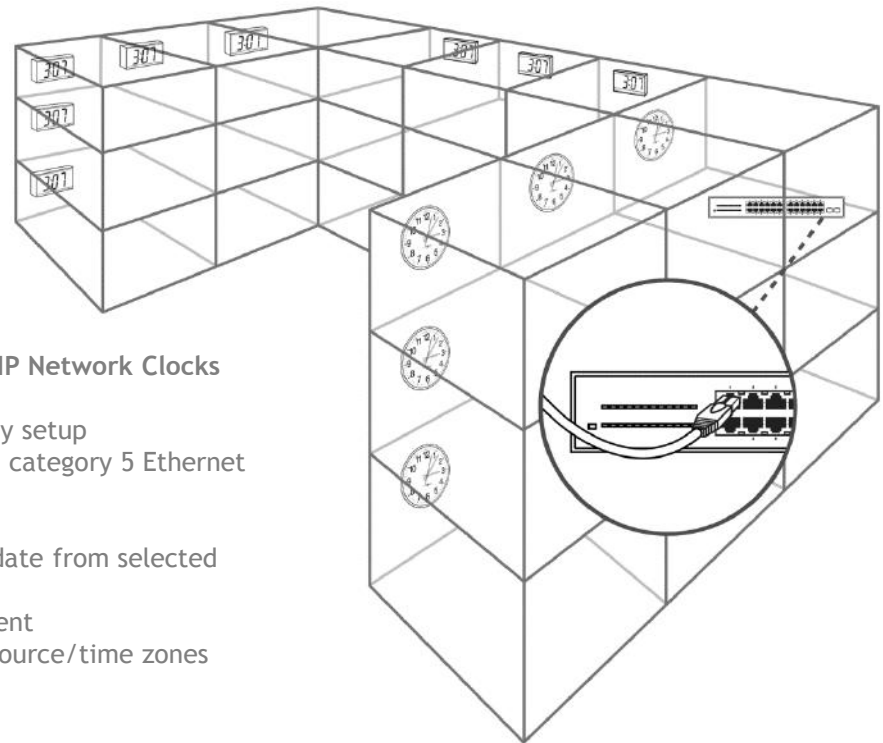

Power over Ethernet IP Network Clocks

- Simple plug and play setup
- Clocks use standard category 5 Ethernet cabling
- Unlimited clocks
- Consistent time update from selected NTP time source
- Software management
- Independent time source/time zones

SECTION 2: What are PoE IP Network Synchronized Clocks and how do they receive time? POE IP NETWORK SYNCHRONIZED CLOCKS DEFINED

Power over Ethernet IP Network Clocks simply connect to existing Ethernet infrastructure and use synchronization software to establish communication and time settings.

In the example to the right, the PoE IP Network Synchronized Clock plugs directly into existing Ethernet infrastructure. Once connected, synchronization software discovers each clock and allows the user to choose universal or individual time source, time zone, and Daylight Saving Time settings.

Analog or Digital PoE IP Network clocks receive a consistent time signal directly over the network and are frequently used in healthcare and education facilities. Some PoE IP Network clock manufacturers also offer external time servers.

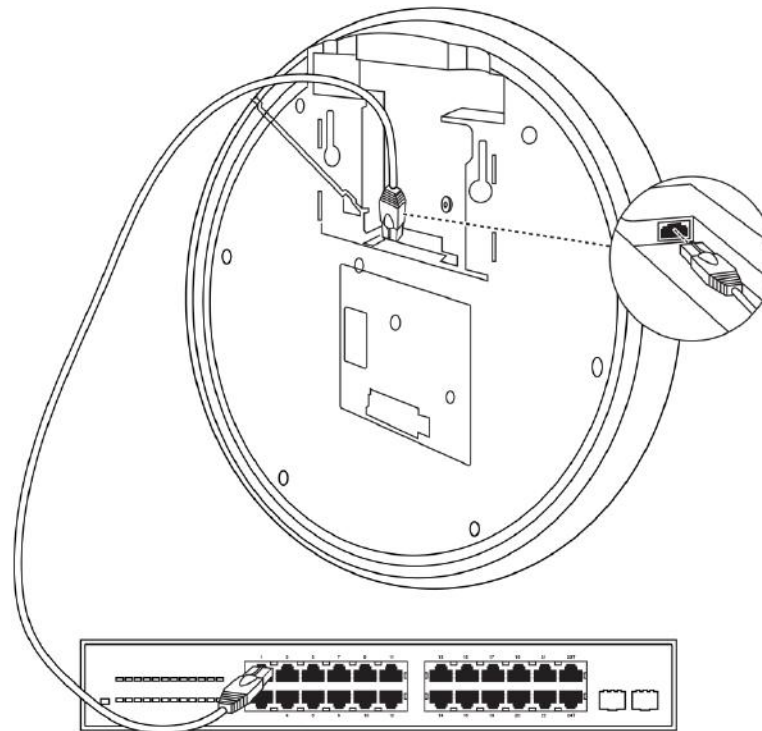

SECTION 2: What are Wi-Fi Wireless Synchronized Clocks and how do they receive time?

Wi-Fi WIRELESS SYNCHRONIZED CLOCKS DEFINED

Wi-Fi Wireless Clocks receive consistent time using Wi-Fi access points.

Wi-Fi Wireless Synchronized Clocks receive consistent time data using Wi-Fi access points. Synchronization software synchronizes all clocks to a selected NTP time server using an internet connection.

A Wi-Fi Wireless clock system ensures perfectly synchronized time throughout an entire building, campus or even over a nationwide network.

Typical business configuration involves attaching several Access Points to a wired network. Wi-Fi clocks must be within range of a wireless access point to receive accurate time.

Wi-Fi Wireless Clocks may be battery operated (analog & LCD digital) or electric (analog & LED digital).

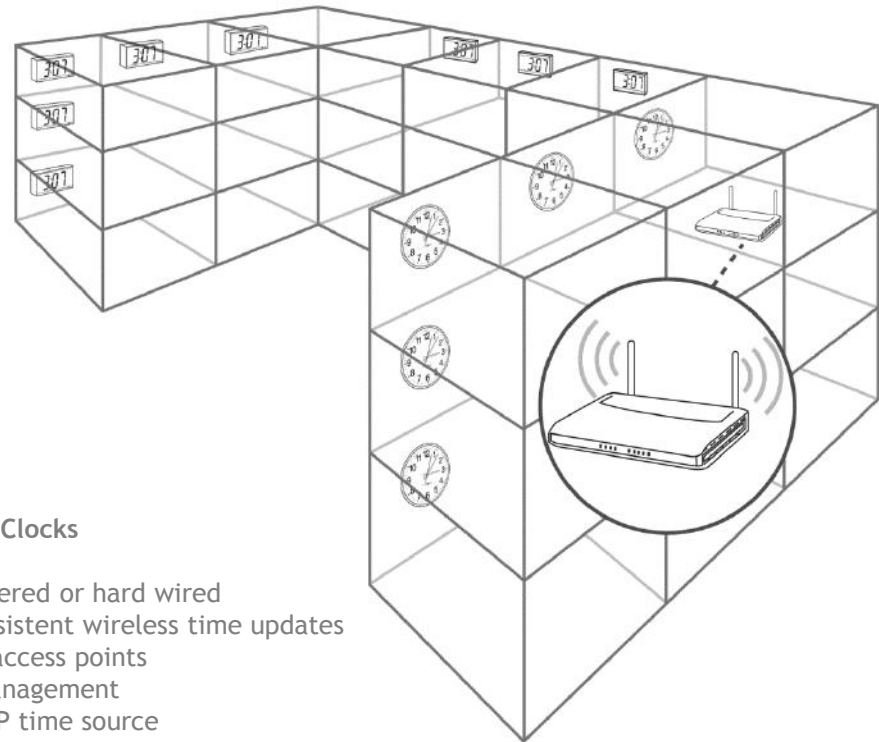

Wi-Fi Wireless Clocks

- Battery powered or hard wired
- Receive consistent wireless time updates using Wi-Fi access points
- Software management
- Selected NTP time source

SECTION 3: How are Synchronized Clock Systems configured?

WIRELESS SYNCHRONIZED CLOCK SYSTEM CONFIGURATIONS

Radio Frequency and PoE IP Network Clocks are configured using a standard network.

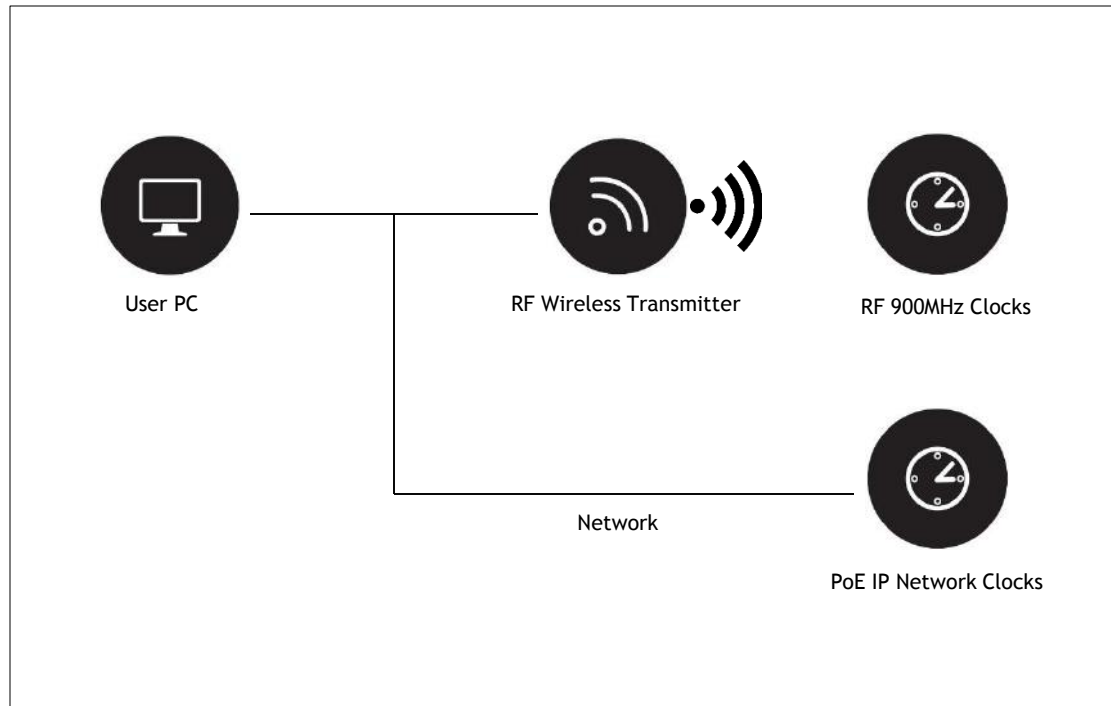

The diagram to the left demonstrates the network and wireless relationships for RF Wireless and PoE IP Network devices.

SECTION 3: How are Synchronized Clock Systems configured? WIRELESS SYNCHRONIZED CLOCK SYSTEM CONFIGURATIONS

Wi-Fi Wireless and PoE IP Network Clocks may be configured using a local network.

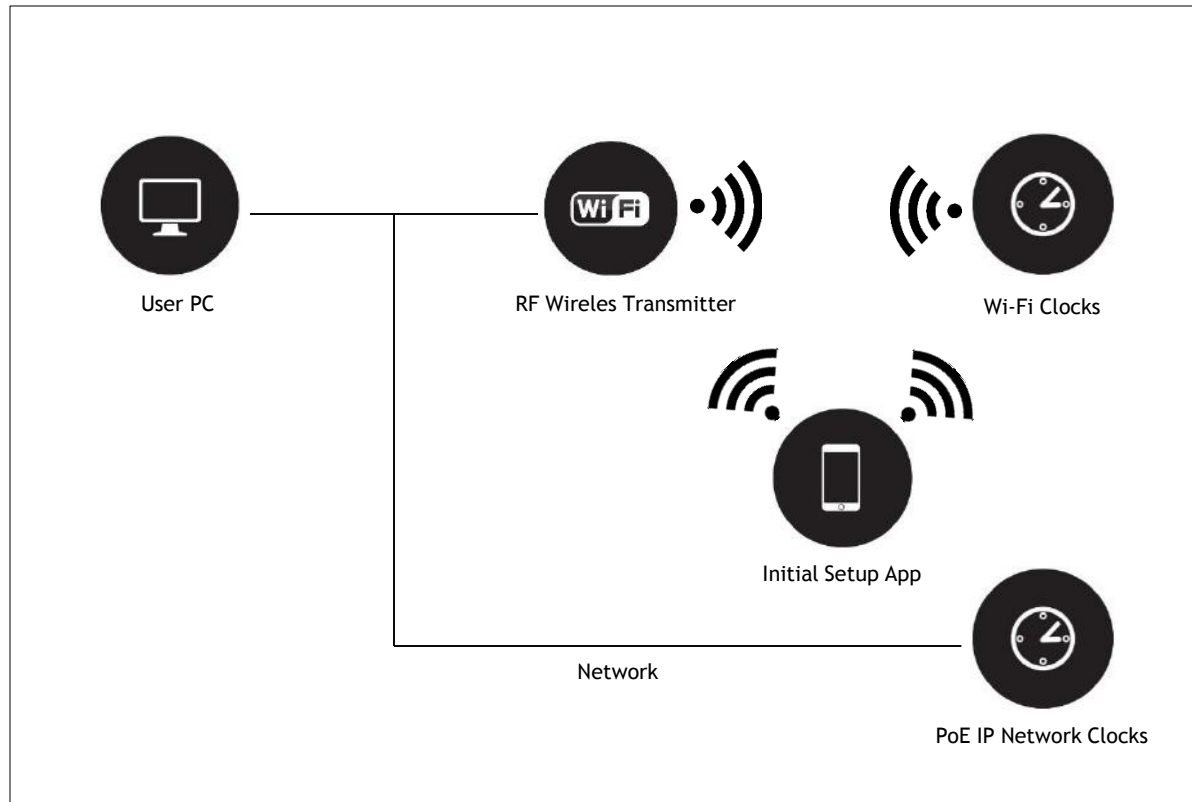

The diagram to the left demonstrates the network and wireless relationships for Wi-Fi Wireless and PoE IP Network devices.

PART 2:

THE SYNCHRONIZED CLOCK SYSTEM PLANNING PROCESS

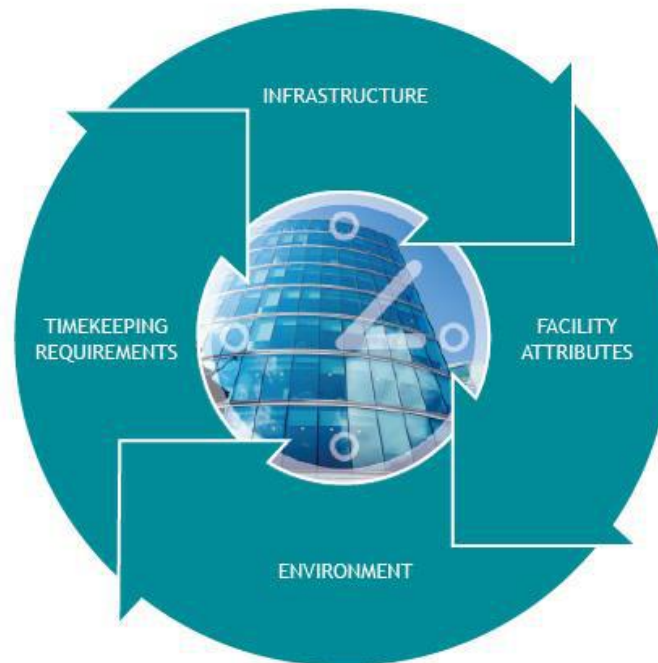

SECTION 1:
HOW TO CHOOSE THE RIGHT SYNCHRONIZED CLOCK
SYSTEM FOR A FACILITY



SECTION 1: How to choose the right Synchronized Clock System for a facility.

THE SYNCHRONIZED CLOCKS SYSTEM PLANNING PROCESS

Like any integrated system, you need to consider the available infrastructure and physical attributes of a facility and surrounding environment.

Planning A Synchronized Clock System.

Now that you understand the benefits of Synchronized Clocks and the different types of systems available, you need to consider specific facility and environmental conditions to ensure equipment performance.

Facility size, building construction, facility contents and geographical topology are all crucial considerations when choosing a Synchronized Clock system.

The chart on the next page will help guide you in selecting the appropriate synchronization method.



Specify the right platform (s)



Specify the right product mix





Specify the right power configuration



SECTION 1: How to choose the right Synchronized Clock System for a facility.

THE SYNCHRONIZED CLOCKS SYSTEM PLANNING PROCESS

Choosing the right platform for a specific environment ensures operational performance.

PLANNING PROCESS MATRIX				
CLOCK SYSTEM PLATFORM	FACILITY SIZE	FACILITY ATTRIBUTES	FACILITY CONSTRUCTION	SURROUNDING TOPOGRAPHY
	250,000 sq ft = 1 Watt Transmitter	1-3 Floors = 1 Transmitter	Signal coverage dependent upon location of Firewalls, metal construction and density of interior partitions. Additional transmitters may be necessary.	Flat
	No Restriction	No Restriction	Extensive Ethernet Infrastructure to support clock placement	No Restriction
	Restricted to Wi-Fi Access Points	Restricted to Wi-Fi Access Points	Wi-Fi signal coverage dependent upon density of interior partitions. Additional Wi-Fi Access Points may be necessary.	No Restriction

SECTION 1: How to choose the right Synchronized Clock System for a facility.

THE SYNCHRONIZED CLOCKS SYSTEM PLANNING PROCESS

Choosing the right clock format for a specific application ensures timekeeping requirements are met.

Analog and Digital Clock Formats.

There are a number of format options available depending on specific timekeeping requirements and regulations.

Ranging from a simple 12-hour Analog clock to a highly visible LED digital clock featuring the hour, minute and seconds (00:00:00), display formats and product mix should be selected based on your specific application.

Refer to the Clock Format Guide on the next page for clock options.











Choose the right product mix



SECTION 1: How to choose the right Synchronized Clock System for a facility.

THE SYNCHRONIZED CLOCKS SYSTEM PLANNING PROCESS

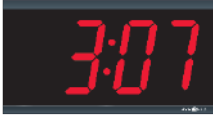
CLOCK FORMAT GUIDE					
CLOCK FORMAT	12 HOUR ANALOG	12 HOUR W/SECONDS ANALOG	12/24 HOUR ANALOG	4 LED DIGIT DIGITAL	6 LED DIGIT DIGITAL
					
DESCRIPTION	12 Hour Dial	12 Hour Dial w/five minute increments	12/24 Hour Dial	00:00 Digital	00:00:00 Digital
APPLICATION	Offices	Educational settings	Environments requiring military time format	Large areas or environments requiring a highly visible time source	Large areas or settings where detailed timekeeping is required
CLOCK SIZE/FORMAT	13" & 16" ANALOG	17" ANALOG	2.5" CHARACTER LED DIGITAL	2.5" LCD CHARACTER LCD DIGITAL	4" LED CHARACTER DIGITAL
					
VIEWING DISTANCE	100ft	135ft	100ft	75ft	250ft

SECTION 1: How to choose the right Synchronized Clock System for a facility.

THE SYNCHRONIZED CLOCKS SYSTEM PLANNING PROCESS

Outfitting a clock system with the proper accessories to meet environmental needs.

Clock System Accessories

There are a variety of enhanced viewing and protective accessories available depending on specific environmental conditions.

Whether you are tasked with outfitting a school gymnasium or a healthcare laboratory, there are specific product applications for enhancing visibility or protecting facility wall clocks.

Refer to the Clock Accessory Guide on the next page for clock options.











Choose the right accessories



SECTION 1: How to choose the right Synchronized Clock System for a facility.

THE SYNCHRONIZED CLOCKS SYSTEM PLANNING PROCESS

CLOCK ACCESSORY GUIDE				
	WALL BRACKETS	CEILING BRACKETS	WIRE GUARDS	WASH DOWN ENCLOSURES
				
				
DESCRIPTION	Analog & Digital Dual Clock Wall Brackets	Analog & Digital Dual Clock Ceiling Brackets	Analog & Digital Chrome Wire Clock Guards	Analog & Digital Polycarbonate NEMA4 Clock Covers
APPLICATION	Enhanced visibility in long hallways (both directions)	Enhanced visibility in expansive areas (both directions)	Protects clocks from damage, theft and vandalism. Specify in areas such as gymnasiums or recreational areas	Shields clocks from dust, debris and moisture. Specify in labs or aquatic facilities

SECTION 1: How to choose the right Synchronized Clock System for a facility.

THE SYNCHRONIZED CLOCKS SYSTEM PLANNING PROCESS

Synchronized Clock Systems are available in a variety of power options.

Analog and Digital Power Options.

There are a number of analog and digital clock power options available depending on available power sources.

Choose from battery operated, 105-120V AC, 105-240V AC, 48V DC or 110/120 Flying Lead power configurations to fit any construction project.

Refer to the Clock Power Guide on the next page for clock power specifications.





Choose the right power configuration



SECTION 1: How to choose the right Synchronized Clock System for a facility.

THE SYNCHRONIZED CLOCKS SYSTEM PLANNING PROCESS

CLOCK POWER GUIDE					
PLATFORM	12 HOUR ANALOG	12 HR W/SEC ANALOG	12/24 HOUR ANALOG	4 DIGIT DIGITAL	6 DIGIT DIGITAL
	3.6 Volt Lithium Battery 105-120V AC	3.6 Volt Lithium Battery 105-120V AC	3.6 Volt Lithium Battery 105-120V AC	105-240V AC (LED)	105-240V AC (LED) 3.6 Volt Lithium Battery (LCD)
	48V DC (Ethernet RJ45) 105-120V AC (Cord)	48V DC (Ethernet RJ45) 105-120V AC (Cord)	48V DC (Ethernet RJ45) 105-120V AC (Cord)	48V DC (Ethernet RJ45) 105-120V AC (Cord)	48V DC (Ethernet RJ45) 105-120V AC (Cord)
	3.6 Volt Lithium Battery 110/220 Flying Leads	3.6 Volt Lithium Battery 110/220 Flying Leads	3.6 Volt Lithium Battery 110/220 Flying Leads	110/220 Flying Leads	110/220 Flying Leads

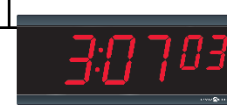
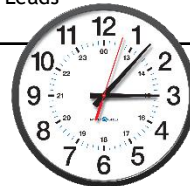
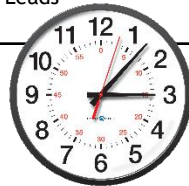
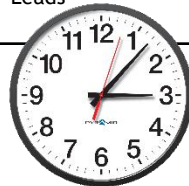

SECTION 1: How to choose the right Synchronized Clock System for a facility.

THE SYNCHRONIZED CLOCKS SYSTEM PLANNING PROCESS

Enhancing a Synchronized Clock Systems with Bell/Tone Systems.

Bell & Tone Systems.

A Synchronized Clock System may be able to support bells or PA tones/announcements to build an integrated system with a timed event schedule.

This type of system promotes synchronized schedules, class or shift changes and bus waves in the educational or manufacturing environment. Many products feature fully-automated deployment software and include schedule customization and multi-zone operation.

Refer to the Bell/Tone System Guide on the next page for clock power specifications.



Choose the right bell/tone systems



SECTION 1: How to choose the right Synchronized Clock System for a facility.

THE SYNCHRONIZED CLOCKS SYSTEM PLANNING PROCESS

BELL/TONE SYSTEM GUIDE			
	24 VOLT BELL RINGER	ETHERNET BELL SYSTEM	ETHERNET TONE SYSTEM
DESCRIPTION	24-Volt Bell Ringer - for signaling timed 24V DC bells and horns	110 Volt Ethernet Bell Ringer - 6 Zone for signaling timed AC bells or horns	110 Volt Ethernet Tone Generator for customizing and managing tone sequence schedule
APPLICATION	Interfaces with Synchronized Clock System	Interfaces with Synchronized Clock System	Interfaces with Synchronized Clock System
ACCESSORIES	24 Volt DC Bells and Horns	110V AC Bells and Horns	

SECTION 2:
WHICH SYNCHRONIZED CLOCK SYSTEMS ARE ENERGY
EFFICIENT?



SECTION 2: Which Synchronized Clock System are energy efficient?

SAVING ENERGY



Depending on the type of clock system, an organization can save thousands of dollars in energy costs.

Energy Efficient Solutions.

The emergence of Green technology initiatives has prompted facility managers, engineers & architects to seek energy-efficient & environmentally-friendly products.

Reducing power consumption and diminishing environmental consequences are essential considerations in the design, construction, operation and maintenance of Green facilities.

Wi-Fi and battery operated RF Wireless analog clocks eliminate electrical power consumption and use lightweight, long-lasting, recyclable lithium batteries. PoE IP Network clocks use cost-effective IEEE.802.3af (Energy Efficient Ethernet) standard requiring minimal power consumption.

POWER CONSUMPTION COMPARISON			
			
CLOCK FORMAT	FLYING LEADS	PoE	BATTERY OPERATED
	.8W	.96W	-
	13W	10W 200mA @ 48VDC	-

BATTERY LIFE EXPECTANCY COMPARISON	
	
Alkaline	6 months
Lithium	Up to 5 years

SECTION 3

BUILD A SYNCHRONIZED CLOCK SYSTEM

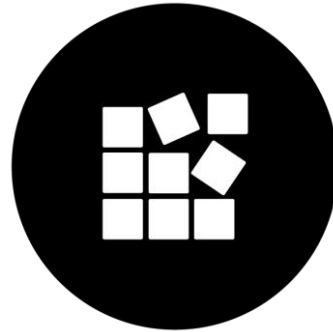

SECTION 3

BUILD A SYNCHRONIZED CLOCK SYSTEM

Consider facility infrastructure and layout.

Apply your newly-acquired knowledge of Synchronized Clocks to choose the ideal system for any facility.

Consider available infrastructure, facility size and layout, as well as construction and content when selecting a clock system. Is Wi-Fi widely available throughout the facility with multiple access points? Are there multiple floors, classroom and departments? Or, are there long hallways or expansive areas requiring a well lit, highly visible time display.

Thoughtful consideration of facility factors will help you select the right synchronization method, power source and product mix for your project.

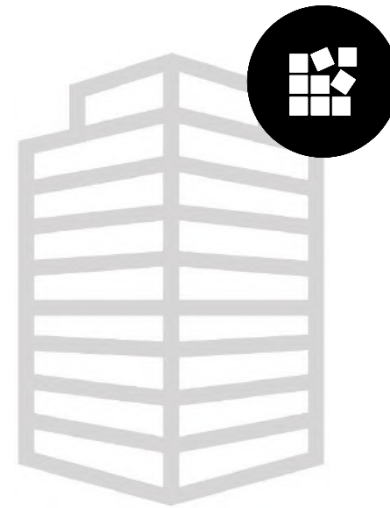

SECTION 3: How to build a Synchronized Clock System.

BUILD A SYSTEM

Size up the facility for the right system.

What type of infrastructure exists in the facility?

Is this a new Ethernet-rich facility ready for networked equipment to be distributed throughout the building or campus? Is Wi-Fi widely available throughout the facility with multiple access points? Or is your project a renovation with retrofitting requirements?

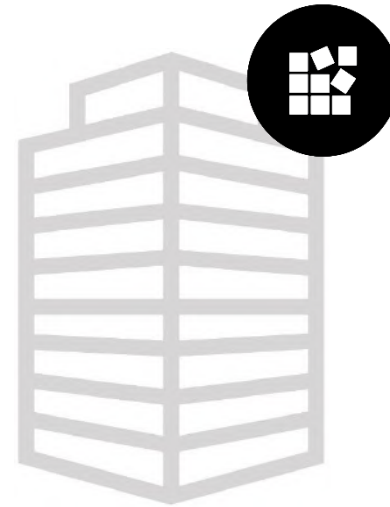

SECTION 3: How to build a Synchronized Clock System.

BUILD A SYSTEM

Size up the facility for the right system.

What type of infrastructure?

Radio Frequency Wireless.

Recommended for small facilities or larger facilities without readily accessible and extensive Ethernet or Wi-Fi infrastructure.



Small facility



Large facility w/o extensive Ethernet or Wi-Fi

SECTION 3: How to build a Synchronized Clock System.

BUILD A SYSTEM

Size up the facility for the right system.

What type of infrastructure?

Power over Ethernet IP Network.
Recommended for facilities with readily accessible and extensive Ethernet infrastructure. Any size organization can benefit from integrating Power over Ethernet IP Network clocks into their overall network design.



Small or large facilities with extensive Ethernet

SECTION 3: How to spec a Synchronized Clock System.

SPEC A SYSTEM

Size up the facility for the right system.

What type of infrastructure?

Wi-Fi Wireless.

Recommended for small or large facilities with adequate Wi-Fi access points. Wi-Fi clocks work reliably with a signal strength of better than -70dBm.

NOTE:

Network security compatibility is a crucial consideration when planning for a Wi-Fi clock system. This will ensure the system security configuration is aligned with local network security parameters (i.e. WPA2 or WPA2 Enterprise).



Small or large facilities with multiple Wi-Fi access points.

SECTION 3: How to build a Synchronized Clock System.

BUILD A SYSTEM

Size up the facility for the right system.

Facility Size & Layout?

There are six simple steps to complete when selecting the specific products necessary for the subject environment.

By answering the following six questions, your Synchronized Clock specification will adequately furnish the job at hand.

1. What is square footage?
2. How many floors?
3. How many buildings? How many wings per building?
4. How many departments, general areas, offices, classrooms?
5. What type of facility construction and content?
6. What type of geographic topography?



SECTION 3: How to build a Synchronized Clock System.

BUILD A SYSTEM

Size up the facility for the right system.

Step 1:

What is the square footage?

Square footage is necessary to determine the wireless signal coverage area (Radio Frequency Wireless Synchronized Clock System).

A 1Watt Radio Frequency Wireless transmitter typically provides 250,000 square feet of coverage. However, this is dependent upon facility construction and content. If a facility exceeds 250,000 square feet, one additional transmitter is required for each additional 250,000 square feet of area.

PoE and Wi-Fi systems can accommodate any square footage, as long as Ethernet wiring and/or Wi-Fi access points are within reach of the clocks.

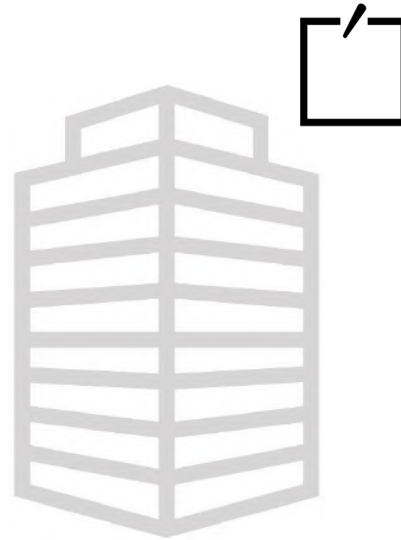

(1) 1Watt RF Wireless Transmitter/250,000 sq. ft.

SECTION 3: How to build a Synchronized Clock System.

BUILD A SYSTEM

Size up the facility for the right system.

Step 2:

How many floors?

If using a Radio Frequency Wireless Clock System, the number of floors determines how many transmitters are needed. Typically a 1 watt transmitter will adequately cover one floor above and one floor below the floor where the transmitter is located.

If a facility has greater than three floors, than one additional transmitter is required for every three floors. The main determining factors in clock synchronization are the distance from the transmitter and the transmitter signal strength.

PoE IP Network and Wi-Fi systems can accommodate any number of floors, as long as Ethernet wiring and/or Wi-Fi access points are within reach of the clocks.

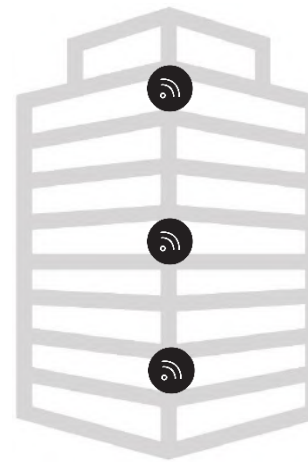

In the example to the left, one RF Wireless Transmitter is strategically placed for every three floors.

(1) 1Watt RF Wireless Transmitter/3 floors

SECTION 3: How to build a Synchronized Clock System.

BUILD A SYSTEM

Size up the facility for the right system.

Step 3:

How many buildings? How many wings per building?

This will determine how many Radio Frequency Wireless transmitters are needed.

In the example to the right, one RF Wireless Transmitter is strategically placed for every three floors for each building. Less or more transmitters may be necessary depending on square footage and facility contents such as firewalls.

In some cases, one transmitter is adequate for more than one building as long as the buildings are within the 250,000 sq. ft. signal range and no internal and/or external obstructions are present.

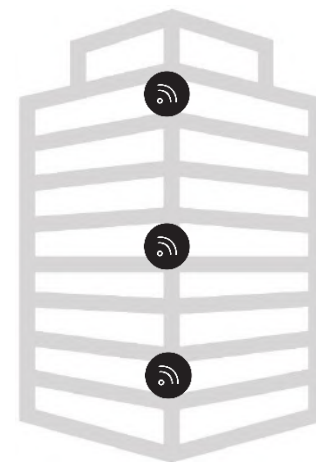
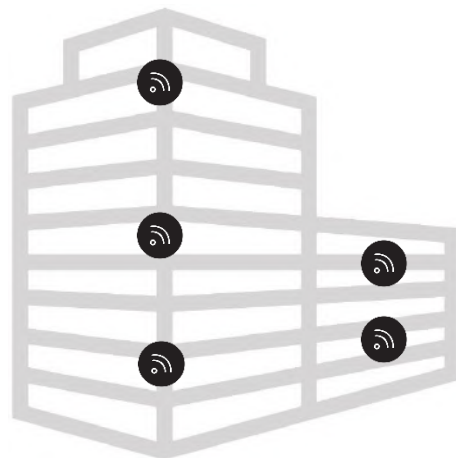

(1) 1Watt RF Wireless Transmitter/3 floors for each building and/or wing.

SECTION 3: How to build a Synchronized Clock System.

BUILD A SYSTEM

Size up the facility for the right system.

Step 4:

How many departments, general areas, offices, classrooms?

This will determine how many clocks are needed. Also consider if there are long hallways or large expansive areas which may require a highly visible time display such as red LED digital clocks or enhanced viewing accessories, such as ceiling mounting brackets.

For specific product recommendations, please refer to the “Clock Format Guide” on p. 45.

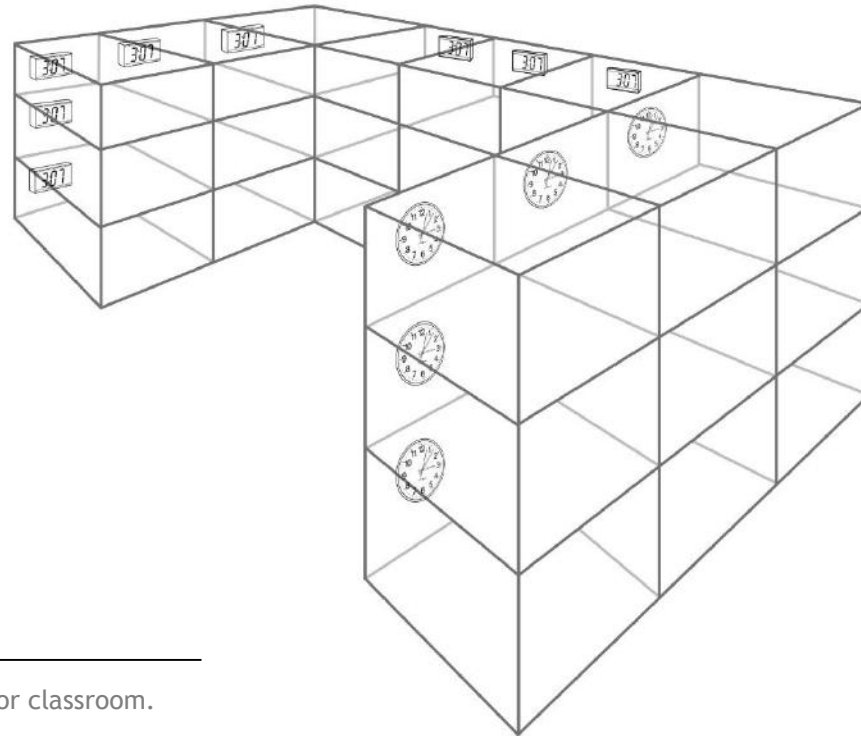

(1) Clock per department, general purpose area, office, or classroom.

SECTION 3: How to build a Synchronized Clock System.

BUILD A SYSTEM

Size up the facility for the right system.

Step 5:

What type of Facility Construction and Contents?

Interior Partition Density? Firewalls? Metal Construction?

If choosing either Radio Frequency or Wi-Fi Wireless Synchronized Clock Systems, be sure to consider facility construction and building materials, such as dense interior partitions, concrete walls, and metal construction and/or shelving. These types of environmental conditions can potentially obstruct a wireless signal, warranting the installation of one or more supplementary transmitters, higher output power level devices (FCC license required), or additional Wi-Fi access points.

Several signal restrictions may mandate an alternative synchronization method, such as Ethernet or Wi-Fi Wireless Clock Systems.

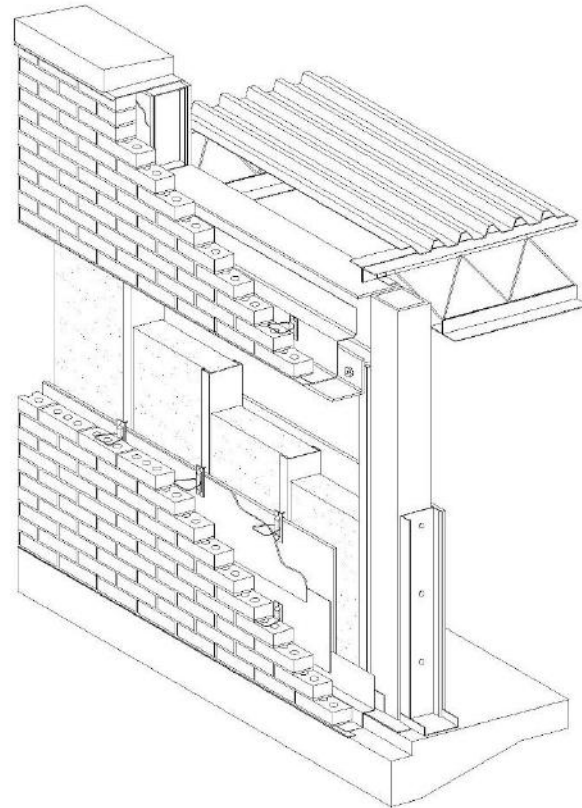

Additional RF Wireless Transmitters or Wi-Fi Access Points may be necessary to accommodate dense interior and exterior walls or metal partitions.

SECTION 3: How to build a Synchronized Clock System.

BUILD A SYSTEM

Size up the facility for the right system.

Step 6:

What Type of Geographic Topography?

This will determine if additional RF Wireless transmitters are required, or if an alternative platform, such as PoE IP Network or Wi-Fi is more suitable.

In the example below, the RF wireless signal is unable to penetrate the geographical obstructions mandating an additional transmitter for the second building or alternative synchronization methods, such as PoE IP Network or Wi-Fi Wireless.



SECTION 3: How to build a Synchronized Clock System.

BUILD A SYSTEM

Cost considerations.

Budget & Benefits?

The cost of a Synchronized Clock System is dictated by synchronization method (RF Wireless, PoE IP Network or Wi-Fi Wireless), number of communication devices (if using a RF Wireless system), as well as the quantity and format of synchronized clocks.

The following information is intended to provide the user with general benchmarks when cost management and budget adherence are considered.

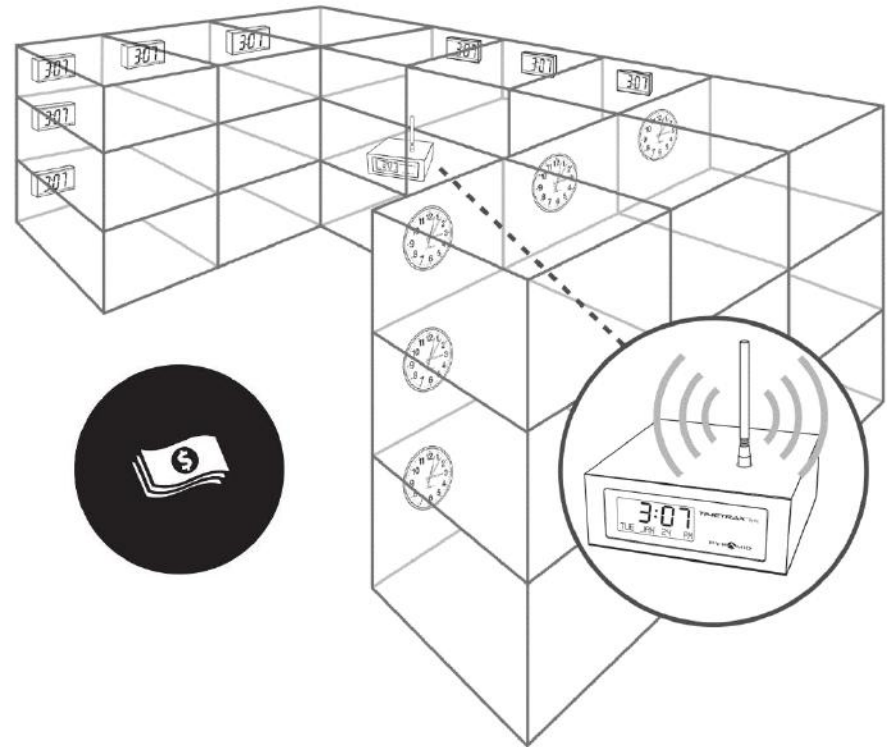

SECTION 3: How to build a Synchronized Clock System.

BUILD A SYSTEM

Cost considerations.

Budget & Benefits? Synchronization Methods.

Radio Frequency Wireless.

An RF Wireless Clock System is the most economical option, costing about 20% less than Power over Ethernet (PoE) IP Network or Wi-Fi Wireless Clock Systems. Radio Frequency Wireless clock systems are simple to set up and use, and provide a dependable time signal.

Power over Ethernet IP Network.

PoE IP Network Clock Systems may cost a bit more, but they are the most reliable and stable synchronized clock systems on the market. These systems do not require an RF Wireless transmitter.

Wi-Fi Wireless.

Typically Wi-Fi clock systems are the most pricey, but they leverage the investment made in an existing Wi-Fi infrastructure.

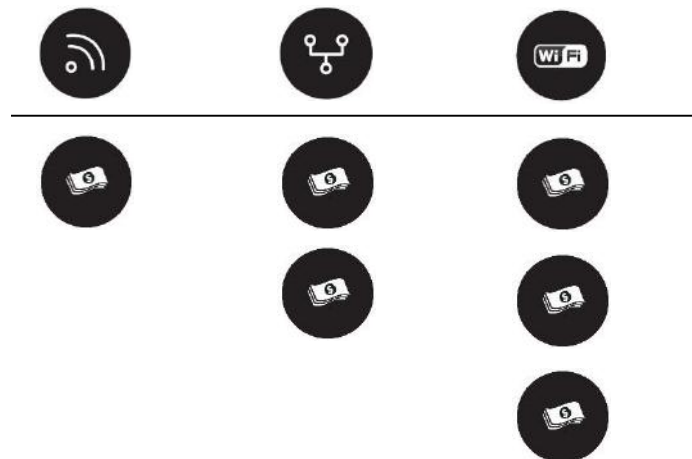

SECTION 3: How to build a Synchronized Clock System.

BUILD A SYSTEM

Size up the facility for the right system.

Budget & Benefits? Power Sources.

Battery Operated

Battery operated clocks eliminate costly electrical wiring, provide installation flexibility and optimal placement.

Battery operated clocks may use either alkaline or lithium batteries, the latter being the preferred method since they are recyclable and long-lasting for up to five years of maintenance-free operation.

Power over Ethernet IP Network

Besides leveraging the cost effectiveness of 110V power, with a PoE IP Network Synchronized Clock System, the constraints of having AC power outlets nearby is eliminated. This power platform provides the flexibility of placing PoE-enabled clocks in optimal locations instead of defaulting to locations where power is available.

The equipment cost of PoE IP Network is slightly higher than that of alternative systems, but like battery operated clocks, budgets and schedules are not impacted by the installation of AC power outlets. The result is a simplified, faster and lower cost installation. The PoE IP Network clock configuration can also facilitate temporary network equipment deployments such as the case with portable classrooms.

Wired

Typically wired clock systems are the most pricey in terms of installation and energy consumption. However, wired installations may be the only option for retrofitting existing clock systems.

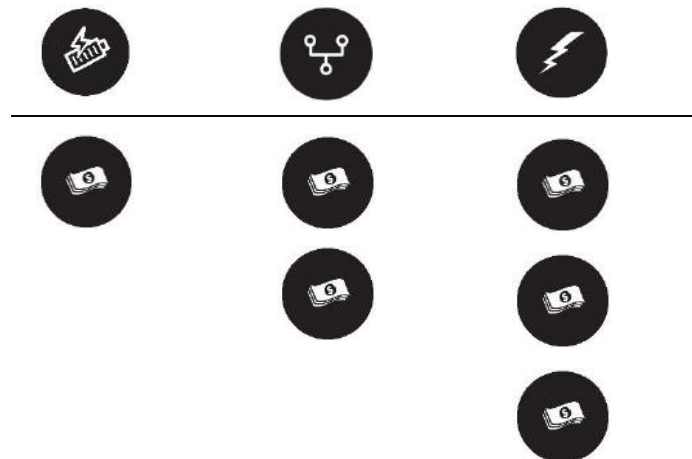

CONCLUSION

TIME TO PUT YOUR KNOWLEDGE TO GOOD USE.

We understand that choosing a clock system can be a daunting task-that's why we've taken the guess work out of your work. Just use the information here to help you select the perfect Synchronized Clock System for your facility and time keeping requirements.

Want to learn more?

Contact our Synchronized Clock Info Center at [888.479.7264 Ext. 807](tel:888.479.7264)
info@ptitime.com
or visit pyramidtimesystems.com.



Glossary of terms.

Analog Clock - a clock that displays the time of day by the position of rotating hands on a dial

Digital Clock - a clock that displays the time digitally, typically in segmented numerals

Synchronized Clocks - clocks which display the same, precise time that is traceable to official time

Radio Frequency Wireless Synchronized Clocks - clocks which use dependable frequency-hopping technology to continuously broadcast a time signal over signaling channels

Power over Ethernet (PoE) IP Network Synchronized Clocks- clocks which receive time data and power through a standard Ethernet cable

Wi-Fi Wireless Synchronized Clocks - clocks which receive accurate time using a Wi-Fi network

Network Time Protocol (NTP) - a networking protocol for clock synchronization between computer systems over data networks

Coordinated Universal Time (UTC)- is the primary time standard by which the world regulates clocks and time

Global Positioning System (GPS) - a space-based satellite navigation system that provides location and time information

Wi-Fi Access Point (AP) - is a device that allows wireless devices to connect to a wired network using Wi-Fi or related standards.

LED - light-emitting diode

LCD - liquid crystal display

ABOUT THIS GUIDE

Compiled & Written By:
Jennifer Altschuler
Marketing Manager,
Pyramid Time Systems

About Pyramid Time Systems.
Pyramid Time Systems empowers organizations worldwide with easy-to-use and intuitive synchronized clock systems, time clocks, document stamps and time clock systems designed to optimize productivity, reliability and efficiency. Our products help manage the workforce, streamline processes, and minimize operating costs.

Headquartered in Meriden, Connecticut, Pyramid Time Systems provides timekeeping products to thousands of enterprises and small companies across a wide array of industries. For more information, visit pyramidtimesystems.com.

