

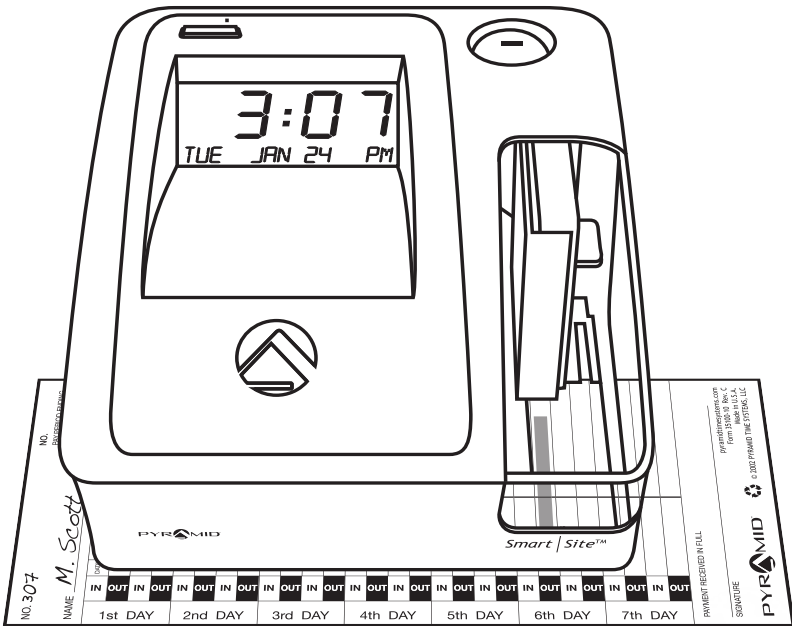

3500SS/3600SS/3700SS

Smart | Site™ Time Clock & Document Stamp
User Guide



STAMP

SIMPLE : SMART®

TABLE OF CONTENTS

TABLE OF CONTENTS 1

PRODUCT OVERVIEW 2

FEATURES 2

CONTENTS 3

GETTING STARTED & INSTALLATION 4

PROGRAMMING & FEATURES SET UP & BUZZERS 4-5

MESSAGES & COUNTER MODE 6-7

BUZZERS 8

PRINTING MODES. 9

ADJUSTING DOCUMENT EDGE 9

USING TIME CLOCK. 10

TIME CARDS 11

TIME CARD PRINT FORMAT 11

PRINTING CUSTOM MESSAGES (3600SS) 12

REPLACING RIBBON CARTRIDGE 13

MASTER RESET. 14

FAQs 14

ACCESSORIES 14

WARRANTY & CUSTOMER SUPPORT 15

SPECIFICATIONS 16

MOUNTING TEMPLATE 3500SS/3600SS 17

MOUNTING TEMPLATE 3700SS 18

PRODUCT OVERVIEW

Thank you for choosing a 3500SS/3600SS/3700SS SmartSite™ Time Clock & Document Stamp! The 3500SS/3600SS/3700SS are our most versatile time clocks, ready to perform employee time tracking, document stamping & preset message stamping. The 3600SS features custom message stamping & sequential page numbering. These clocks feature the exclusive patent pending SmartSite™ viewing guide and are equipped with a red LED alignment guide to ensure perfectly aligned time card punches & document stamping time after time.

The 3500SS/3600SS/3700SS is able to punch employees In & Out and stamps time sensitive documents using one of 14 preset messages. The 3600SS also stamps custom messages with up to 2 lines of alphanumeric type and stamps sequential page numbering up to 9999 consecutive stamps using semi-automatic or manual stamping. These clocks feature an adjustable document edge to accommodate any size document. Simple set-up, simple operation & simple ribbon changes make these time clocks a favorite with small business!

Please read through this User Guide for simple set-up & operation.

TIME CLOCK & DOCUMENT STAMP : FEATURES

Employee Capacity	Unlimited
Alignment	SmartSite™ Red LED guide
Custom Type (3600SS)	Date stamp & up to 2 lines (16 characters per line) alphanumeric custom type
Preset Messages	14 Preset Messages for stamping time sensitive documents
Counter Mode (3600SS)	Sequential numbering up to 9999
Loading	Side, adjustable document edge
Ribbon Ink	Black
Audio Signal (3600SS)	Buzzer
Language Printing	English, Spanish & French
Printing	Semi-automatic or manual
Display	Time, date & day of week (AM/PM or Military Time Format)
Printing Format	Date & Time (AM/PM, Military, Military Hundredths, Military Tenths)
Printing	Dot matrix
Automatic Time Reset	Short months, Leap Year & Daylight Savings Time
Battery Back-Up	Safeguards data & settings for up to 7 days without power
Tamper-Proof	Security lock protects against costly time theft
Warranty	1-Year manufacturer's limited warranty

SET UP

- 1 Remove time clock from carton & place on a flat, level surface.
- 2 Unlock & remove top cover.
- 3 Connect power adaptor in port located behind display screen & plug unit into AC wall outlet.

WALL MOUNTING

- 1 Select a location convenient to employees clocking IN & OUT. Be sure power outlet is within 5 feet of mounting location.
- 2 Use masking tape to hold mounting template on wall, making certain template is positioned so bottom of time clock is approximately 45 inches from floor.
- 3 Drill holes using template as a guide.
- 4 Remove the template from the wall and install #10 screws (not included), leaving approximately 3/16 inch of the screw exposed.
- 5 For sheetrock walls, use the plastic anchors.
- 6 Hang the time clock on the wall, aligning keyholes on the rear with the screw heads. Press downward on the time clock until it lowers onto the screws.
3700SS: tighten the screws after hanging the clock.
- 7 Plug unit into AC wall outlet.

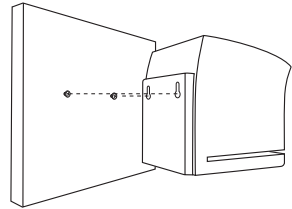

PROGRAMMING

Use key to unlock and remove cover.

- 1 Locate programming buttons labeled **SELECT**, ▲/◀ and ▼/▶.
- 2 Press **SELECT** and using ▲/▼ scroll to display desired feature is (see chart on page 5).
- 3 After display feature is changed, press **SELECT** button to save change. Repeat this step for other features until you cycle back to main display showing TIME/DATE.
- 4 Press ▲/◀ or ▼/▶ to scroll through feature options.

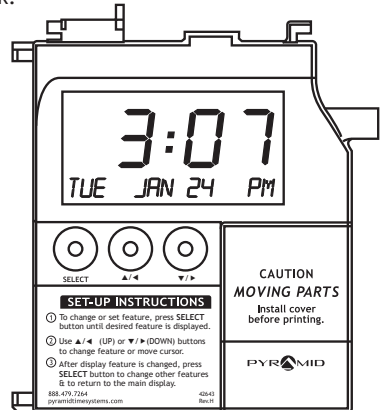

- ▲/◀ Moves cursor LEFT in Custom Messaging (3600SS)
- ▼/▶ Moves cursor RIGHT in Custom Messaging (3600SS)

3500SS/3600SS/3700SS TIME CLOCK & DOCUMENT STAMP FEATURES SET UP

FEATURE (SELECT)	DISPLAY	DEFAULT SETTINGS	OPTIONS (SCROLL ▲▼)
Set Language	LANG	ENGLISH	ENGLISH, French (FRANCAIS), Spanish (ESPAÑOL)
Set Date Format	DATE FMT	MMDDYY	MM/DD/YR (USA), DD/MM/YR (EURO), YY/MM/DD
Set Year	SET YEARR	2021	DISPLAYED YEAR +/- 1 Year
Set Month	SET MONTH	JAN	DISPLAYED MONTH +/- 1 Month
Set Date	SET DAY	1	DISPLAYED DATE +/- 1 Day
Set Daylight Savings Time (DST) Rule	DAYL'T SAV	USA	USA: USA DST: Begins 2nd SUN of MAR, Ends 1st SUN of NOV 2am EURO: European DST: Begins Last SUN of MAR, Ends Last Sun of OCT 1am OTHER: Set a custom DST Rule. ¹ 2am OFF: No adjustment for DST.
Set Format	DSPLY FMT	AM/PM	AM/PM: 12 Hour, MIL: Military, 24 Hour
Set Printed Time Format	PRINT FMT	AM/PM	AM/PM: 12 Hour (e.g. 3:30PM) MIL: Military, 24 Hour (e.g. 15:30) ATAAP: Military, 24 Hour, Minutes expressed in hundredths of one hour (e.g. 15.50) 24H.1: Military, 24 Hour, Minutes expressed in tenths of one hour (e.g. 15.5)
Set Print Direction	PRINT DIR	RIGHT	Right = Print in right direction on time card. Left = Print in left direction on time card.
Set Mode	MODE	AUTO	SEE PRINTING MODES PAGE 9
Setup Pre-programmed message	SET FMT MSGS	NO/DATE TIME	SEE PREPROGRAMMED MESSAGES PAGE 6
Setup Custom Message	EST MSGS (1,2)	NOT USED	SEE CUSTOM MESSAGING, PAGE 7 (3600SS Only)
Schedule a Buzzer Event (3600SS)	SET EVENT	NO	NO: No event(s) scheduled. YES: Schedule event(s) SET EVENT #1-50, Page 8
Set Hour	SET HOUR	12PM	DISPLAYED HOUR +/- 1 Hour
Set Minutes	SET MINUTES	0	DISPLAYED MINUTE +/- 1 Minute

¹ SELECT DAYL'T SAV=OTHER. SCROLL & SELECT START & END SUNDAY (Available options are the 1st, 2nd, 3rd, 4th and last Sunday of each month). Remember: The number of weeks in a given month changes each year. You will have to reprogram your custom DST if either the START or END date falls on the last day of the month.

MESSAGES & COUNTER MODE

The 3500SS/3600SS/3700SS function as a document stamp and are preprogrammed with 14 common message formats. In addition, the 3600SS allows you to enhance each of these preprogrammed messages with up to two lines of customizable print, or with a sequential counter.

PREPROGRAMMED MESSAGES

- ① In the **FMT=DATE TIME (3500SS/3700SS)** menu or the **SET FMT MSGS (3600SS)** menu, press **▲(UP)** or **▼(DOWN)** to choose “YES”.
- ② Press **SELECT**.
- ③ Press **▲(UP)** or **▼(DOWN)** to scroll through preprogrammed messages. (see chart below)¹
- ④ Press **SELECT** to choose desired message² & advance to next menu.
- ⑤ If no custom message is desired “**EST MSG1=NOTUSED**”, press **SELECT**, or to program a custom message “**EST MSG1**”, follow steps on page 7. (3600SS Only)
- ⑥ If custom message is not desired “**EST MSG2=NOTUSED**”, press **SELECT**, or to program a second custom message “**EST MSG2**”, follow steps on page 7.

SET FORMAT MESSAGES (SET FMT MSGS)

DISPLAY	EXAMPLE
FMT=DATE TIME (Default Settings)	JUL 12 07:46PM
FMT=DATE YR TIME	JUL 12 '20 07:46PM
FMT=DATE YR APVD	JUL 12 '20 APVD
FMT=DATE YR FAXD	JUL 12 '20 FAXD
FMT=DATE YR FILE	JUL 12 '20 FILE
FMT=DATE YR IN	JUL 12 '20 IN
FMT=DATE YR OUT	JUL 12 '20 OUT
FMT=DATE YR PAID	JUL 12 '20 PAID
FMT=DATE YR RCVD	JUL 12 '20 RCVD
FMT=DATE YR SENT	JUL 12 '20 SENT
FMT=DATE YR ORIG	JUL 12 '20 ORIG
FMT=DATE YR VOID	JUL 12 '20 VOID
FMT=DATE YR USED	JUL 12 '20 USED
FMT=DATE YR CMPL	JUL 12 '20 CMPL



¹By default, clock will print DATE TIME format if no message is selected.

²Selected preprogrammed message will print first (date stamp on 3600SS).

NAVIGATE TO CUSTOM MESSAGES (3600SS)

- ① Set: SET FMT MSGS = YES, then press SELECT
- ② Set: (your) FMT, then press SELECT
- ③ Set: CST MSG1 = USE, then press SELECT

Display will show 4 lines:

Line A: NUMBERS, Space  and Arrow 

Line B: CAPITAL LETTERS, Space  and Arrows  

Line C: CLR (clear), DONE, COUNT and Arrow 

Line D: CUSTOM MESSAGE 1 (up to 16 places) (Blinking place to set)

- ④ ◀ (LEFT) or ▶ (RIGHT) moves character to **dark back ground** in each line (right/left).
- ⑤ The arrow with a **dark background** moves the cursor to other line (A,B,or C) after pressing SELECT.
- ⑥ The character (number/letter/space) with a **dark background** is registered in a blinking space of CUSTOM line after pressing SELECT and the next space starts to blink.
- ⑦ If you make a mistake set cursor to “CLR” and press SELECT to clear last character or hold SELECT (3 sec) to clear all characters and then start again.
- ⑧ To set whole CUSTOM MESSAGE 1 for Counter Set for “COUNT” and press SELECT.
- ⑨ To finish a message move the cursor “DONE” to **dark background** and press SELECT.
- ⑩ CST MSG2 = NOT USED - apply the same roles as CST MSG1.

NOTE: IF “CST MSG1=NOT USE”, the clock setting goes to “SET EVENT”. Then “CST MSG1=NOT USE” and “CST MSG2=USE” will not be printed. The counter “CST MSG2” will be incrementing internally (when it was set “USE” and “COUNTER”).

COUNTER MODE (3600SS)

The counter mode is activated when SELECT “<COUNTER>” is in custom message position (see step 8 & 9 above). Every “DATE STAMP” is counted.

An increasing number (1,2,3,-9999) will print on the second or third time you print following “date stamp” or “custom message” (during a three second period).Once 9999 is reached, numbers will reset automatically back to 1.

NOTE: The counter is reset when set “CLR” and press SELECT then set “COUNT” and press SELECT again.



¹You may not move the cursor of custom message backwards. (see step 7 above)

²It is recommended to reset time after creating custom messages.

SET EVENT USING BUZZER (3600SS)

The 3600SS Time Clock & Document Stamp has an internal buzzer to alert workers of start times, breaks, lunch and dismissal times.

**MENU : SET EVENT ▲▼
 SCHEDULE AN EVENT (e.g. Ring Internal Buzzer)**

FEATURE (SELECT)	DISPLAY	DEFAULT SETTING	OPTIONS (SCROLL ▲▼)
Set Event Schedule	SET EVENT *	NO	Scroll ▲(UP) or ▼(DOWN) to schedule event
Assign the Event a Number (1-50)	SET EVENT *		SET EVENT (e.g.1, 2, 3 ... 50)
Set the Event's Duration	EVENT *	OFF	OFF, .5 SEC, 1-15 SEC (determines length of time buzzer)
Set the Event's Hour	EVENT * HR =	12 HR: 12AM 24 HR: 00	EVENT HOUR +/- One Hour 12 HR: 12AM-11PM 24 HR: 00-23
Set the Event's Minute	EVENT * MIN =	00	EVENT MINUTE +/- One Minute (e.g. 00, 17, 59)
Set the Event's Day	EVENT * DAY =	ALL	All week event, ALL: SUN-SAT Monday thru Friday Event: M-F One day event: SUN, MON, TUE, WED, THU, FRI, SAT

PRINTING MODES

The 3500SS/3600SS/3700SS can be set to print semi-automatically or manually using the SET MODE feature. When set to AUTO the clock will print whenever the actuator is activated.

When set to MANUAL, the clock will only print when the “manual button” located in the left, top corner above the display screen is pressed.

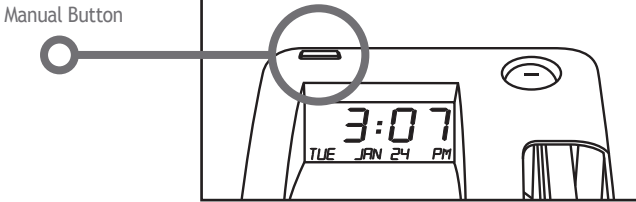

ADJUSTING DOCUMENT EDGE

The actuator can be adjusted to accommodate different document widths.

- 1 Disconnect power plug before adjustment
- 2 Place clock on its side so the viewing window is facing towards you.

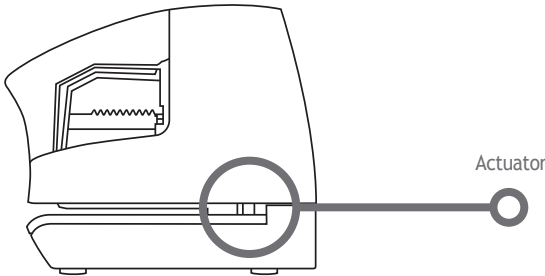

- 3 Locate the “actuator adjustment knob” on the bottom of the clock.
- 4 Push “actuator adjustment knob” in while sliding the actuator back or forth to adjust position.

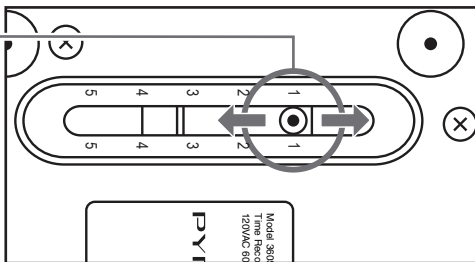

DISCONNECT POWER PLUG
BEFORE ADJUSTMENT

USING TIME CLOCK

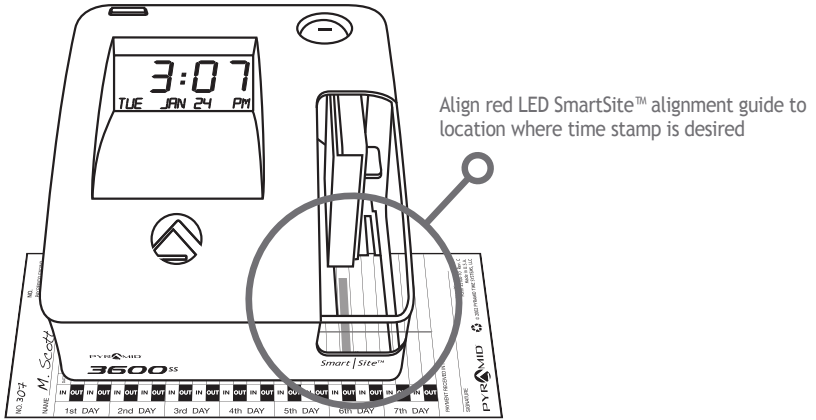

- ① To punch time card or stamp document, gently feed time card (35100-10 or 35100-10F) or document into slot at base of time clock, while aligning red LED SmartSite™ alignment guide to location where time stamp is desired.
- ② A - Continue to feed time card or document until the print actuator is activated. (Mode=Auto)
B - Feed time card or document, and press Manual Button. (Mode=Manual)

TIME CARDS

NAME		NO. PAY PERIOD ENDING	
DATE	HR	MIN	OT
1st DAY	7:00 AM		
	7:30 AM		
	8:00 AM		
	8:30 AM		
	9:00 AM		
	9:30 AM		
	10:00 AM		
2nd DAY	7:00 AM		
	7:30 AM		
	8:00 AM		
	8:30 AM		
	9:00 AM		
	9:30 AM		
	10:00 AM		
3rd DAY	7:00 AM		
	7:30 AM		
	8:00 AM		
	8:30 AM		
	9:00 AM		
	9:30 AM		
	10:00 AM		
4th DAY	7:00 AM		
	7:30 AM		
	8:00 AM		
	8:30 AM		
	9:00 AM		
	9:30 AM		
	10:00 AM		
5th DAY	7:00 AM		
	7:30 AM		
	8:00 AM		
	8:30 AM		
	9:00 AM		
	9:30 AM		
	10:00 AM		
6th DAY	7:00 AM		
	7:30 AM		
	8:00 AM		
	8:30 AM		
	9:00 AM		
	9:30 AM		
	10:00 AM		
7th DAY	7:00 AM		
	7:30 AM		
	8:00 AM		
	8:30 AM		
	9:00 AM		
	9:30 AM		
	10:00 AM		
TOTAL			
BASE			
AMOUNT			
TOTAL EARNINGS			
TOTAL DEDUCTIONS			
BALANCE DUE			
NO. OF EMPLOYEES			
SEC. 401			
FED. INC.			
INSURANCE			
GEN. INC.			
SIC. INC.			
SIC. BEN.			
DUES			
BONDS			
MED. C.			
SIGNATURE			
PAYMENT RECEIVED IN FULL			
 WWW.PYRAMIDSYSTEMS.COM FROM: BOSTON, MA, U.S.A. MADE IN U.S.A. © 2002 PYRAMID TIME SYSTEMS, LLC			

Time card #35100-10 or 35100-10F

TIME CARD PRINT FORMAT

The time card (#35100-10 or 35100-10F) is used for weekly pay periods.
 Printing will appear as follows:

PUNCH IN JUL 12 7:00AM
 Prints Month, Date & Punch Time

PUNCH OUT JUL 12 3:00PM
 Prints Month, Date & Punch Time

PRINTING CUSTOM MESSAGES (3600SS)

Scenario: It is 7:46AM on 7/12/20. You have selected "DATE & TIME" from the Set Format Messages ("SET FMT MSGS") menu. You have set Custom Message 1 "(CST MSG 1)" to PYRAMID TIME SYS. You have set Custom Message 2 to "<COUNTER>". The clock will print to your document as follows:

First print DATE JUL 12 '20 7:46AM
Second print MESSAGE 1 PYRAMID TIME SYS (print within 3 seconds after First print)
Third print MESSAGE 2 1 (print within 3 seconds after the Second print)



After clock prints date stamp (line 1) "JUL 12 '20" you have three seconds to print custom message (line 2), "PYRAMID TIME SYS". If you do not print first custom message (line 2, second print) within 3 seconds, the 3rd print (message 2) will not print and the clock will revert to date stamp (line 1).

Example A

First print DATE JUL 12 '20 7:46AM
Second print JUL 12 '20 7:46AM (if 3 seconds or more goes by, after the 1st print, message will not appear)

If longer then 3 seconds the message won't appear, and clock defaults back to time. The counter will advance but will not print because we didn't make 2nd print during the first 3 seconds.

After you print first custom message (line 2), "PYRAMID TIME SYS", you have three seconds to print second custom message (line 3), "1". Again, if you do not print second custom message (line 3) within 3 seconds, the clock will revert to date stamp (line 1).

Example B

First print DATE JUL 12 '20 7:46AM
Second print MESSAGE 1 PYRAMID TIME SYS
Third print MESSAGE 2 JUL 12 '20 7:46AM (if 3 seconds or more goes by, after the 2nd print, message will not appear)

After you print second custom message (line 3), "1", the clock automatically will return to date stamp (line 1).

Example C

First print DATE JUL 12 '20 7:46AM



NOTE: Each time date stamp prints(Examples A, B & C) the counter advances +1 (even though sequential numbers did not print).

REPLACING RIBBON CARTRIDGE

- 1 Unlock and remove cover.
- 2 Press ▲(UP) for 3 seconds to park ribbon carriage (Clock has to display TIME).
- 3 Unplug power to time clock ***IMPORTANT***.
- 4 Turn clock on its side so ribbon cartridge & holder are on top.
- 5 Slide actuator to far left and out of the way which is located underneath the clock. (see diagram).
- 6 Remove old ribbon cartridge by holding tab and lifting up.
- 7 Snap in new ribbon cartridge between printer head and mylar.
- 8 Turn the knob, follow arrow to stretch the ribbon. It will turn easily.
- 9 Replace cover, lock unit & plug in.
- 10 Feed time card through unit to test print quality.
- 11 Readjust the actuator.

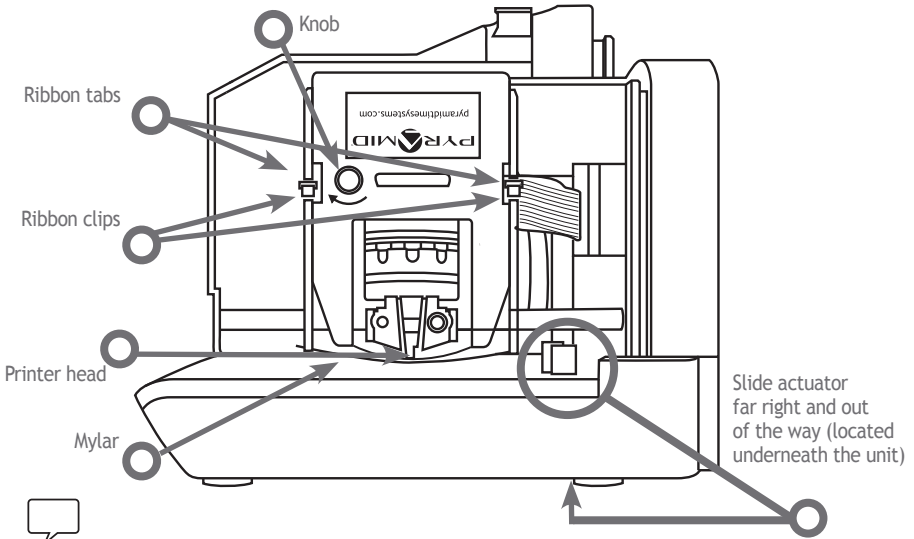

If ribbon is not completely over print head the resulting print will show incomplete characters. If ribbon cartridge is not completely snapped in holder, the resulting print will be increasingly lighter.

MASTER RESET

NOTE: This will delete all settings and reset to factory defaults

- ① Unplug power to time clock.
- ② Press & hold ▲(UP) button while plugging unit back in.
- ③ Release ▲(UP) button when “BB:BB, TIME NOT SET” displays.
- ④ Re-program time clock.

FAQS

Q: Do I have to use special cards?

A: Pyramid 35100-10 or 35100-10F (French) cards are designed for use with the 3500SS/3600SS/3700SS when it is used for payroll, but you can use it to stamp other documents.

Q: What does ATAAP mean?

A: ATAAP is the acronym used by the U.S. government that describes how time is accounted for using hundredths of hour (i.e. 1.25 hrs = 1hr 15min.)

ACCESSORIES

3500SS/3600SS/3700SS : ACCESSORIES

PART #	DESCRIPTION
5000R	Replacement Ink Ribbon Cartridge
35100-10	Time Cards (100pk)
35100-10M	Time Cards (1000pk)
35100-10F	Time Cards (100pk) English/French
35100-10FM	Time Cards (1000pk) English/French
400-10	10 Capacity Adjustable Time Card Rack
400-3	25 Capacity Adjustable Time Card Rack
400-X	25 Capacity Expanding Time Card Rack
41479K	Replacement Key
300-1	Heavy Duty Metal Time Card Rack, 25 Card Capacity

LIMITED HARDWARE WARRANTY

- Pyramid Time System warrants its equipment to original user against defective material or workmanship for a period of 1-year from date of purchase. Proof of purchase & purchase date are required for warranty service on this product.
- Please remember to register your product at pyramidtechnologies.com/ProductRegistration
- Pyramid Time Systems' responsibility under this warranty is limited to replacement of defective part(s). Replacement is the sole discretion of Pyramid Time Systems.
- For Return Shipments to Pyramid Time Systems, product must be shipped in its original carton or equivalent. The cost & method of return freight for warranted product is the sole responsibility of the customer. Pyramid Time Systems will not assume any responsibility for loss or damage incurred in shipping.
- Pyramid Time Systems reserves the right to determine whether parts failed because of defective material, workmanship or other causes.
- Failure caused by accident, alteration, misuse or improper packaging of returned unit is not covered by this warranty.
- Any repair done by the customer without the consent from Pyramid Time Systems will -ally void the warranty.
- Users in countries other than Canada and USA should contact the Dealer from whom the unit was purchased.
- The rights under this warranty are limited to the original user and may not be transferred to subsequent users.

CONTACT US:

For more information, visit pyramidtimesystems.com or call our technical support team at **888.479.7264** during regular business hours: **8:30am-5pm EST, M-F**, or email customer_support@ptitime.com

SPECIFICATIONS

3500SS/3600SS/3700SS : SPECIFICATIONS

OPERATING CONDITIONS

Temperature 0° C - 50° C, 32° F - 122° F

Humidity 10-95% RH, non condensing

POWER 100-240VAC, 50/60 Hz

POWER FAILURE

Battery Back-Up Hold time and date for life of battery

Battery Life 10 Years

CALENDAR Automatic Leap Year & Daylight Savings Time, Year up to 2099

CLOCK ACCURACY Less than 30 seconds/year

WEIGHT

3500SS/3600SS 2.65lbs (1.2kg)

3700SS 4.75lbs (2.15kg)

DIMENSIONS

3500SS/3600SS 6.125inW x 5.75inH x 6.75inD (15.5cm x 14.6cm x 17.2cm)

3700SS 8inW x 6inH x 6.5inD (20.3cm x 15.24cm x 16.51cm)

CERTIFICATIONS UL and CUL (power supply)

MOUNTING Desktop or Wall mountable



CONTACT US:

For more information, visit pyramidthimesystems.com or call our technical support team at **888.479.7264** during regular business hours: **8:30am-5pm EST, Monday-Friday.**

Copyright © 2024 Pyramid Time Systems, LLC. All rights reserved.



3500SS/3600SS MOUNTING TEMPLATE
3500SS/3600SS PLANTILLA DE MONTAJE
3500SS/3600SS MODELE DE MONTAGE

SCREW GUIDE TEMPLATE BELOW IS ACTUAL SIZE
LA PLANTILLA DE GUÍA DE TORNILLO A CONTINUACIÓN ES DE TAMAÑO REAL
LE MODE D'EMPLOI ET SCHÉMA DES VIS CI-DESSUS EST DE TAILLE RÉELLE

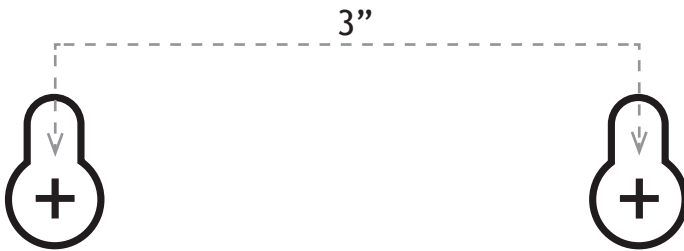

UP/ ARRIBA / EN HAUT



LEVEL LINE MARKER/MARCADOR DE LÍNEA DE NIVEL/ REPÈRE DE LA LIGNE DE NIVEAU

3700SS MOUNTING TEMPLATE/PLANTILLA DE MONTAJE/MODELE DE MONTAGE

SCREW GUIDE TEMPLATE BELOW IS ACTUAL SIZE

LA PLANTILLA DE GUÍA DE TORNILLO A CONTINUACIÓN ES DE TAMAÑO REAL

LE MODE D'EMPLOI ET SCHEMA DES VIS CI-DESSUS EST DE TAILLE RÉELLE

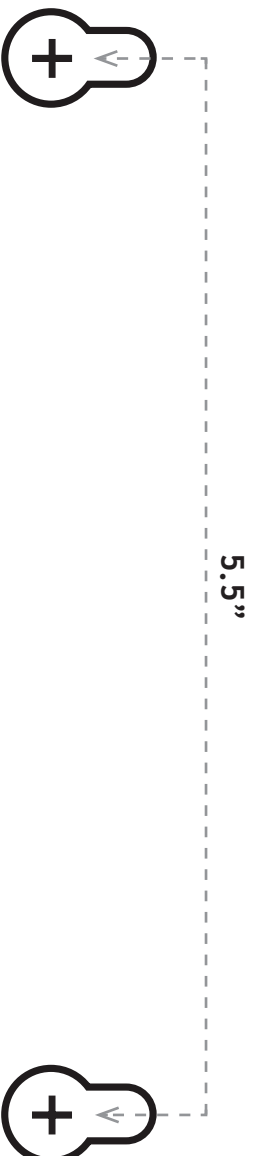

UP / ARRIBA / EN HAUT



LEVEL LINE MARKER/MARCADOR DE LÍNEA DE NIVEL/ RÉPÈRE DE LA LIGNE DE NIVEAU

SIMPLE : SMART[®]



CONTACT US:

For more information, visit pyramidtimesystems.com or call our technical support team at **888.479.7264** during regular business hours: **8:30am-5pm EST, Monday-Friday.**

Copyright Information

© 2024 Pyramid Time Systems, LLC. All rights reserved.

Reproduction, adaptation or translation without prior written permission is prohibited, except as allowed under copyright laws.

The information contained herein is subject to change without notice. The only warranties for Pyramid Time Systems products are set forth in the express warranty statements accompanying such products. Nothing herein should be construed as constituting an additional warranty. Pyramid Time Systems shall not be liable for technical or editorial errors or omissions contained herein.

I2279FS Rev P

888.479.7264